



OCEAN VOYAGER

USER MANUAL

S-VDR DR-100S

OCEAN VOYAGER MARINE ELECTRONICS SYSTEMS

CONTENTS

1	GENERAL	3
1.1	About S-VDR	3
1.2	System Configuration	3
1.3	System Description	6
1.3.1	Data Acquisition Unit (DAU)	7
1.3.2	Remote Alarm Panel (RAP)	7
1.3.3	Indoor & Outdoor Microphone Units	8
1.3.4	Fixed Protective Capsule (FPC)	9
1.3.5	Video Capture Interface (VCI)	10
1.3.6	Data Acquisition Card (DAC)	10
2	OPERATION	11
2.1	Power On/Off	11
2.2	Operation of Remote Alarm Panel (RAP)	12
2.2.1	Alarm Codes	13
2.2.2	Backup Disc	14
2.3	Operation of VDR App	15
2.3.1	Login	15
2.3.2	Live Data	19
2.3.2.1	System Status	19
2.3.2.2	Supply Status	20
2.3.2.3	Equipment	21
2.3.2.4	Audio Channel	25
2.3.2.5	Video Capture	26
2.3.2.6	Alarm	26
2.3.2.7	System Log	27
2.3.3	Player	29

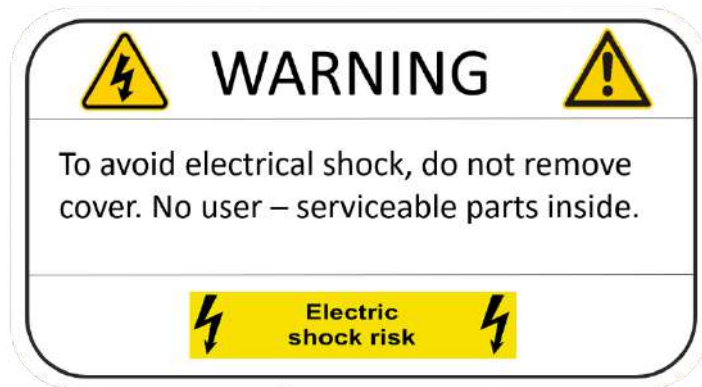

This document prepared for S-VDR DR-100S. Before starting installation read the instructions first. Before start of using the product make sure settings done properly and in accordance with this document. For to protect from damages move carefully. For this product to work effectively check the Compass Safe Distance first.



In accordance with IMO regulations, the S-VDR shall be kept operational of all times and be powered off only for maintenance purposes.

1 GENERAL

1.1 About S-VDR

The purpose of a Simplified Voyage Data Recorder (S-VDR) is to maintain a store, in a secure and retrievable form, of information concerning the position, movement, physical status, command and control of a vessel over the period leading up to, and following, an incident having an impact thereon. Information contained in S-VDR shall be made available to both the administration and the shipowner. This information is for use during any subsequent investigation to identify the cause(s) of the incident.

DR-100S is the first generation of Ocean Voyager S-VDR product. It is the easiest S-VDR to install and maintain. The product is designed to meet the following standards:

1. MSC.333 (90): Adoption of Revised Performance Standards for Shipborne Voyage Data Recorders.
2. MSC214 (81): “Amendments to the Performance Standards for Shipborne/Shipborne Simplified Voyage Data Recorder”.
3. IEC 61996-2 {Ed.2.0} 2007: Maritime Navigation and Radiocommunication Equipment and Systems-Shipborne Voyage Data Recorder (VDR)-Part 2: Simplified Voyage Data Recorder (S-VDR)-Performance Requirements, Methods of Testing and Required Test Results.
4. IEC 60945 {Ed.4.0} 2002: Maritime Navigation and Radiocommunication Equipment and Systems-General Requirements-Methods of Testing and Required Test Results.

1.2 System Configuration

DR-100S comprises of 7 components as below;

NO	COMPONENT	PART	DR-100S	CATEGORY
1	Data Acquisition Unit	DR-102	1 Pcs	Protected
2	Remote Alarm Panel	DR-106	1 Pcs	Protected
3	Indoor Microphone Unit	DR-101	4 Pcs	Protected
4	Outdoor Microphone Unit	DR-117	2 Pcs	Protected
5	Fixed Protective Capsule	OVM-6000	1 Pcs	Exposed
6	Float Free Capsule	VEP8V	1 Pcs	Portable
7	Junction Box	DR-116	2 Pcs	Protected

FFC and FPC are optional. FFC and FPC can be used separately or both capsules together. In case one capsule used, there will be one junction box set.

In case there is no place for outdoor microphone, microphone sets may not be included.

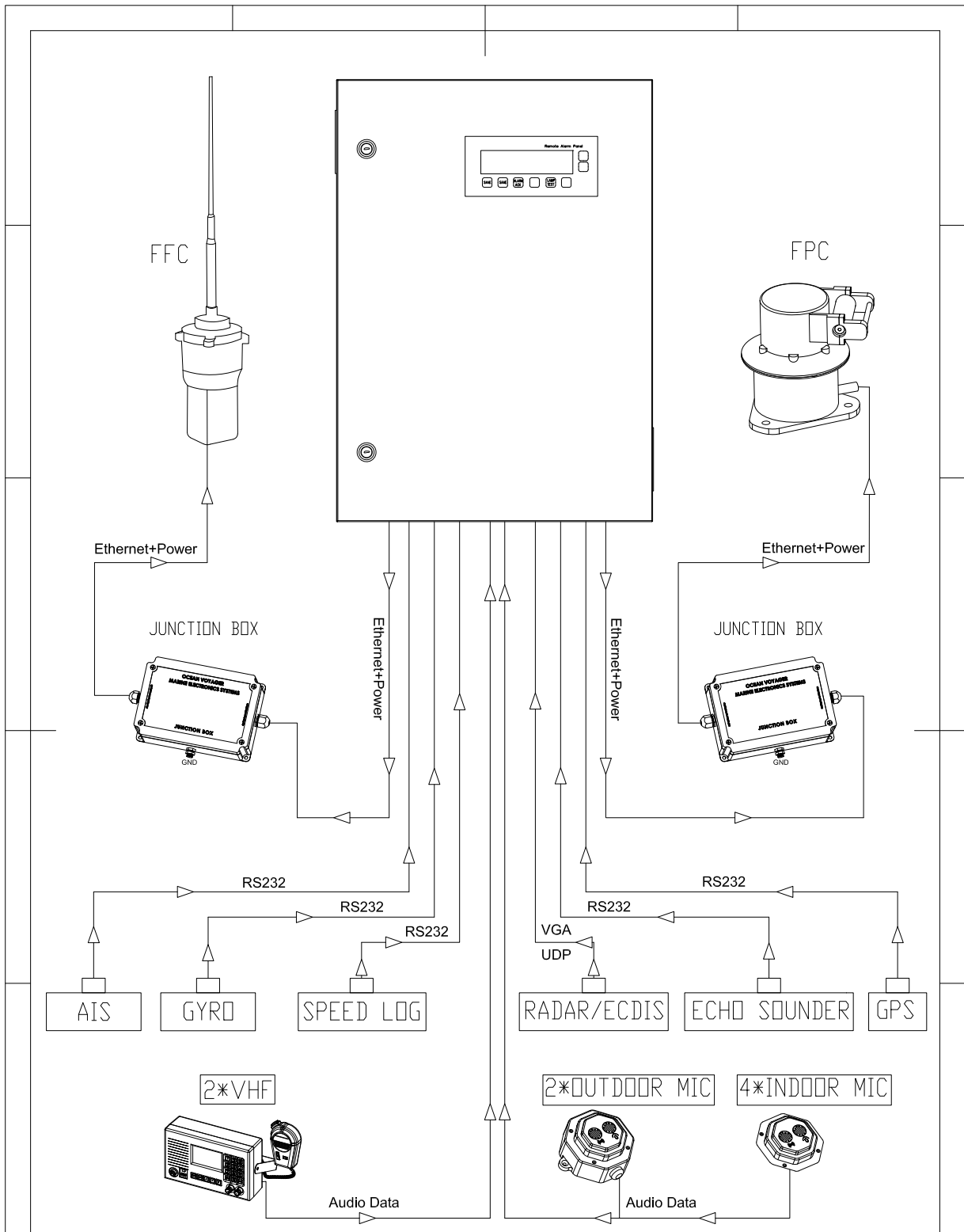

	NAME	DATE		
DRAWING	MUSTAFA DUYSAK	02.06.2021		
APPROVED	RECEP SENYIGIT	02.06.2021		
			SIMPLIFIED VOYAGE DATA RECORDER	
REVISION NO				
	DIMENSIONS IN MM			



**OCEAN VOYAGER
MARINE ELECTRONICS
SYSTEMS**

DR-100S

DOCUMENT CODE: OCN.MD.1010

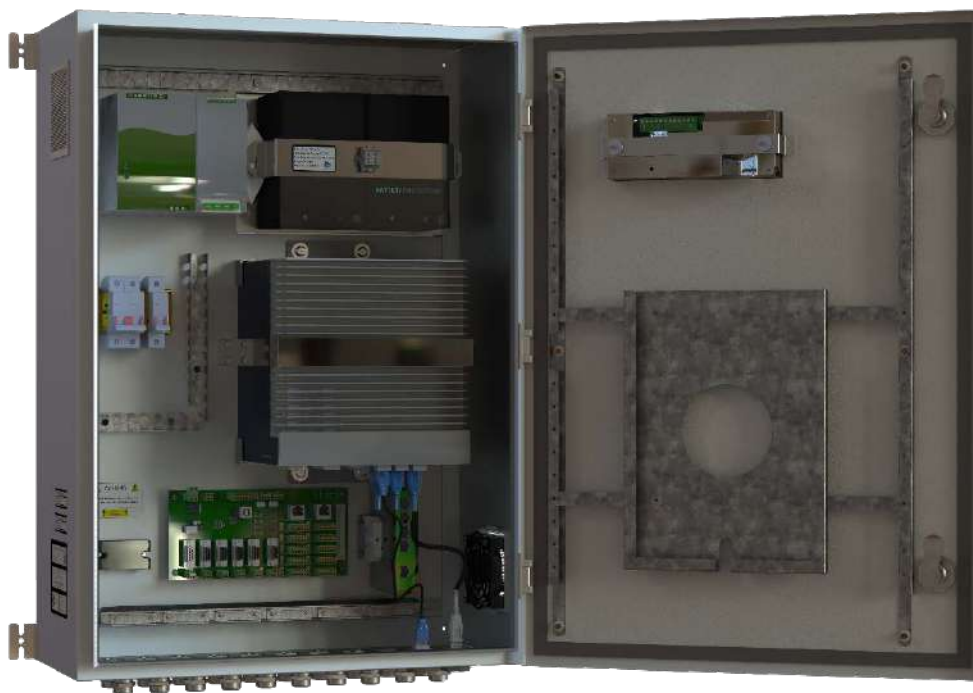
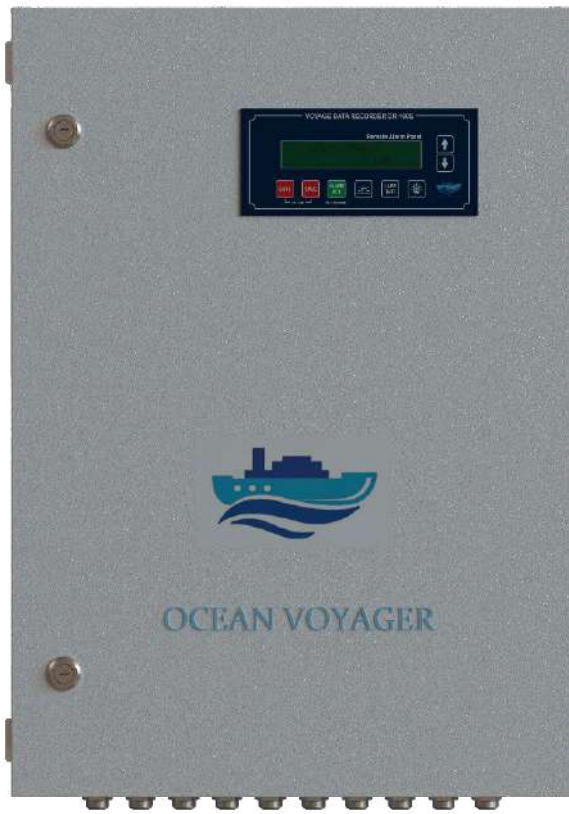

1.3 System Description

The S-VDR system continuously store the data in FPC and FFC for 24 hours by overwriting the old data with new data.

Following data may be recorded by DR-100S;

- Date and Time (UTC)
- Ship's Position
- Speed
- Heading
- Depth (Echo sounder)
- AIS
- Bridge Audio
- Communications Audio
- Radar Screen Images
- ECDIS Screen Images

When power supply fails;

DR-100S is powered by 110-220VAC 50/60 Hz. If both the ship's main power and emergency power source fails, DR-100S will be powered by internal batteries to keep recording bridge audio. The batteries run the system for 2 hours.

1.3.1 Data Acquisition Unit (DAU)

Processor, video module, power switch, audio module, main board are located in the Data Acquisition Unit (DAU). DAU controls the running of the entire system. The Processor's Data Recording Unit with 128GB/SSD records the last 24 hours data and is accessible by LAN connection while protected from any unauthorized changes. The DAU provides 6 channels of microphone input, 2 channels of VHF audio input, up to 2 ECDIS and 2 radar inputs and 6 serial data inputs as well.



1.3.2 Remote Alarm Panel (RAP)

Remote Alarm Panel (RAP) is to check, display and acknowledge the alarms generated by DAU.

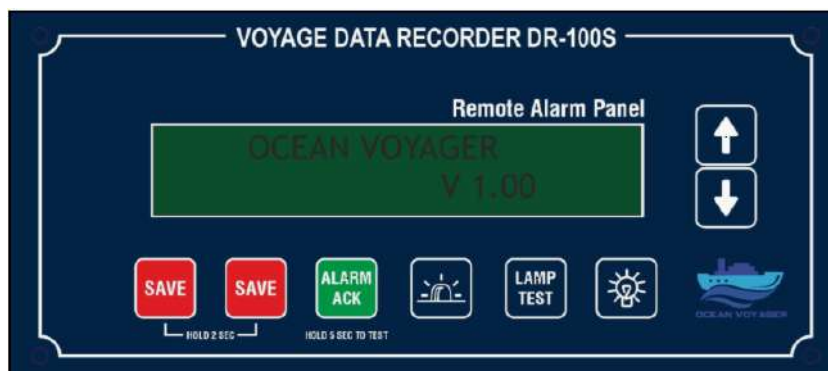

**There are two options for RAP. Mounted on the DAU cover and box RAP for separate installation.

1.3.3 Indoor & Outdoor Microphone Units

The S-VDR system optionally comes with two types of the microphone units, indoor microphones, and outdoor microphones. Outdoor microphones are protected against water ingress.

- **Indoor Microphone Unit (IMU)**

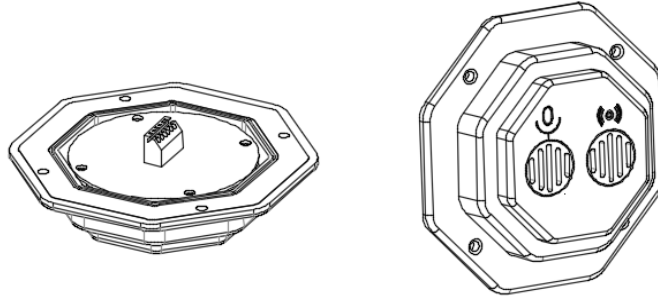

Use microphone screws for mounting microphone tightly. Make sure four screws tighten properly.

- **Outdoor Microphone Unit (OMU)**

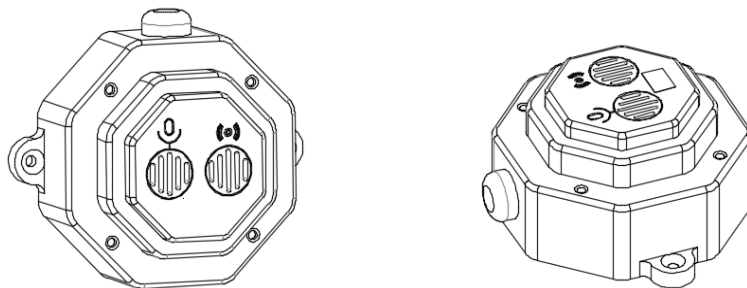

Outdoor microphones must be mounted carefully against cable damages. Cables must be kept away from any damage or paint. Do not apply paint on any microphone cables. After mounting outdoor microphones, use sealing paste to seal cable input.

1.3.4 Fixed Protective Capsule (FPC)

Fixed Protective Capsule (FPC) (OVM-6000) with memory capacity of 128GB supports data recording time for 24 hours. The capsule is built to withstand extreme environmental conditions such as 1100°C temperature, penetration, high underwater pressure, and immersion while maintaining the data integrity.

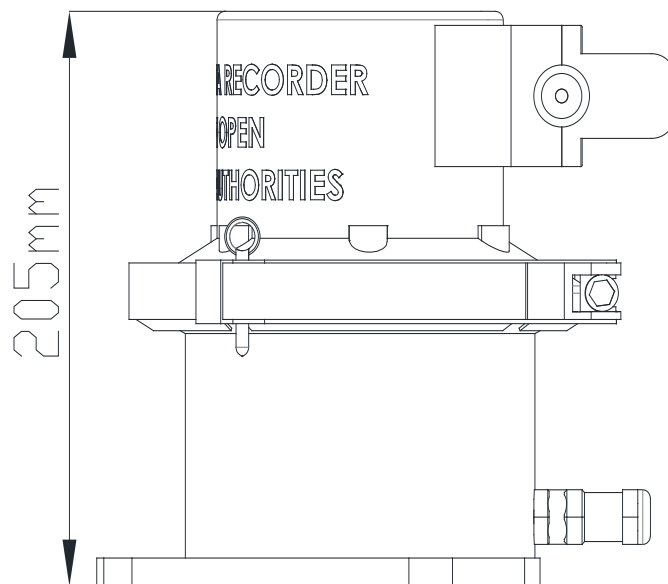
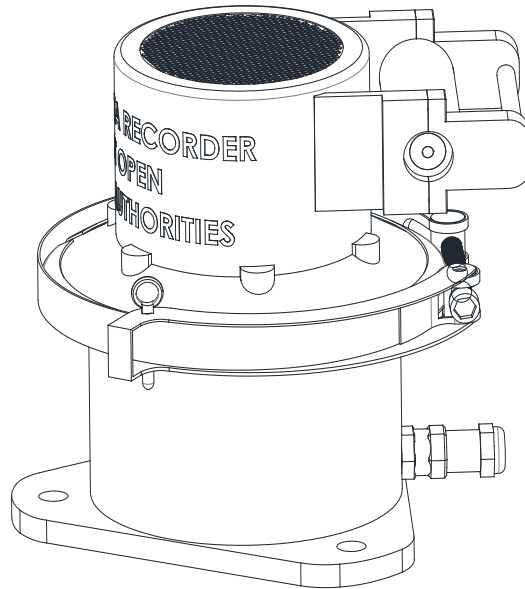

1.3.5 Video Capture Interface (VCI)

Video Capture Card (VCC) is used to convert DVI-VGA data into video frames. The VGA/ DVI/ HDMI/ YPbPr data input supported up to 2560 x 1440 high-definition resolution. This unit is optional for DR-100S. DAU processor may use LAN connection to receive video signals via UDP format. There are up to two radars and two ECDIS data supported by this system. The VGA/DVI cable connection from radar and ECDIS directly done with VCC. VCC comes with VGA to DVI connector. UDP format connection can be done by LAN cable with the processor directly.



1.3.6 Data Acquisition Card (DAC)

Data Acquisition Card (DAC) is used to convert audio and contact signals into recording format. It processes 8 channels audio data, power supply unit signals and UPS unit signals.



DAQ Card and distribution panel (DISPAN) are in connection by SCSI cable. DISPAN and DAQ card has female SCSI connectors. It comes with SCSI cable connected.

2 OPERATION

2.1 Power On/Off

NOTICE!

In accordance with IMO regulations, the S-VDR shall be kept operational of all times and be powered off only for maintenance purposes.



- **Power on:**

Use the key to open the panel cover of DAU. The AC power switch and battery power switches are located on the left middle corner.

Switch on the AC power switch before switching on the battery switch in the respective sequence to start up the S-VDR system. The S-VDR runs its startup process for about 2 minutes.

NOTE:

110-220VAC is the main power supply for the S-VDR system. When power supply lost, the internal batteries will automatically take over to provide the required power supply.

Internal power supply feeds the system 2 hours according to MSC.163(78) Annex 26.

- **Power off:**

In order to power off the S-VDR system, switch off the battery power first and then switch off the AC power switch.

NOTE: In case not to follow power off directions, system may occur malfunction. Follow the power off instructions.

2.2 Operation of Remote Alarm Panel (RAP)

The Remote Alarm Panel (RAP) can be operated by direction keys on the panel.



Under normal operation, the operator is able to;

- Alarm acknowledges
- Lamp test & buzzer test
- Adjust brightness level
- Emergency save data to Emergency Backup disc which located under the DAU.

Panel Key	Description
Save	Hold 2 (Two) sec. on both 2 (Two) buttons to lock last 4 hours data in Emergency Backup Disc
Alarm ACK	Hold 5 (Five) sec. to run system test - Push once for silence the alarm
Buzzer	Buzzer hole - No button
Lamp Test	Runs lamp test and buzzer test
Lamp	Adjust brightness level
Down	Move down - View alarms
Up	Move up - View alarms

The alarm codes that listed on the RAP screen listed by time generated.

When ACK button pushed on RAP the ACK button light for specific alarm turns off and buzzer stops. If problem solved before pushing the button, alarm code does not disappear from the screen. ACK button must pushed. For silencing buzzer push the ACK button anytime. After the problem solved acknowledged alarm disappears from the screen. For each alarm ACK button must pushed. Move down or move up to see other alarms and push ACK button for each alarm displaying on the screen.

2.2.1 Alarm Codes

#	Code	Description	Message	Troubleshooting
01	101	AC 110V/220V Lost	AC 110V/220V Lost	Check AC power switches and ship supply
02	102	Battery Discharge	Bat Discharge	Check AC power switches and ship supply
03	103	Battery Voltage Lost	Bat Voltage Lost	Check battery cable connections and battery powers
04	104	DC Voltage Lost	DC Voltage Lost	Check DC power supply unit connections
05	105	Audio Channel 1 Online Test Fail	Aud. Ch1 Online Fail	Check mic. cable connections and fuse
06	106	Audio Channel 2 Online Test Fail	Aud. Ch2 Online Fail	Check mic. cable connections and fuse
07	107	Audio Channel 3 Online Test Fail	Aud. Ch3 Online Fail	Check mic. cable connections fuse
08	108	Audio Channel 4 Online Test Fail	Aud. Ch4 Online Fail	Check mic. cable connections and fuse
09	109	Audio Channel 5 Online Test Fail	Aud. Ch5 Online Fail	Check mic. cable connections and fuse
10	110	Audio Channel 6 Online Test Fail	Aud. Ch6 Online Fail	Check mic. cable connections and fuse
11	111	Audio Channel 7 Online Test Fail	Aud. Ch7 Online Fail	Check VHF cable connections and fuse
12	112	Audio Channel 8 Online Test Fail	Aud. Ch8 Online Fail	Check VHF cable connections and fuse
13	113	Audio Channel 1 Manuel Test Fail	Aud. Ch1 Man Fail	Check mic. Cable connectors
14	114	Audio Channel 2 Manuel Test Fail	Aud. Ch2 Man Fail	Check mic. Cable connectors
15	115	Audio Channel 3 Manuel Test Fail	Aud. Ch3 Man Fail	Check mic. Cable connectors
16	116	Audio Channel 4 Manuel Test Fail	Aud. Ch4 Man Fail	Check mic. Cable connectors
17	117	Audio Channel 5 Manuel Test Fail	Aud. Ch5 Man Fail	Check mic. Cable connectors
18	118	Audio Channel 6 Manuel Test Fail	Aud. Ch6 Man Fail	Check mic. Cable connectors
19	119	Audio Channel 7 Manuel Test Fail	Aud. Ch7 Man Fail	Check VHF Cable connectors
20	120	Audio Channel 8 Manuel Test Fail	Aud. Ch8 Man Fail	Check VHF Cable connectors

21	121	Fix Capsule Connection Lost	FPC Conn Lost	Control capsule cable connector and connections – Check LAN cable connections and fuse
22	122	Float Capsule Connection Lost	FFC Conn Lost	Control capsule cable connector and connections – Check LAN cable connections and fuse
23	123	Fix Capsule App Not Running	FPC Not Running	Contact service
24	124	Float Capsule App Not Running	FFC Not Running	Contact service
25	125	AIS No Connection	AIS No Connection	Control device cable connector and connections
26	126	Gyro No Connection	Gyro No Connection	Control device cable connector and connections
27	127	Sounder No Connection	Sounder No Conn	Control device cable connector and connections
28	128	Speed Log No Connection	Speed Log No Conn	Control device cable connector and connections
29	129	GPS No Connection	GPS No Connection	Control device cable connector and connections
30	130	RAP No Connection	RAP No Connection	Control device cable connector and connections and fuse
31	131	Dis-Pan No Connection	DISPAN No Conn	Control PCB board cable connector and connections
32	132	Inlet Fan Fail	Inlet Fan Fail	Control Fan cable connector and connections
33	133	Outlet Fan Fail	Outlet Fan Fail	Control Fan cable connector and connections
34	134	Emergency Backup Disk Fail	BUP Disk Fail	Contact service
35	135	Emergency Backup Disk Capacity Fail	BUP Disk Cap Fail	Contact service
36	136	Backup Fail	Backup Fail	Contact service
37	137	GPS Time Difference	GPS Time Dif.	Check GPS time
38	138	Backup Quota Full-Contact Service	Backup Quota Full	Contact service
39	1000	Backup Started	Backup Started	No action needed
40	1001	Backup Finished	Backup Finished	No action needed

2.2.2 Backup Disc

The emergency USB Backup Disc must stay plugged in the port under the DAU. If emergency backup buttons pushed for 2 seconds, last 4 hours data will be downloaded to USB backup disc. After backup complete alarm, disc can be removed. During normal operation USB disc must stay plugged in. It takes about 15 minutes to download last 4 hours data to emergency backup disc. Backup data can be downloaded only three times. After 3 times backup downloaded, contact service alarm displays. For to fix the alarm contact service immediately. Do not change or damage USB backup disc.

2.3 Operation of VDR App

2.3.1 Login

Set below settings on PC before using VDR application.

- 1- Open "Control panel"
- 2- Click on "Network and Internet"
- 3- Click on "Network and Sharing Centre"
- 4- On the left upper corner click on "Change Adapter Settings"
- 5- Double click on "Ethernet"
- 6- Click on "Properties"
- 7- Double click on "TCP/IPv4"
- 8- Click on "Use the following IP address"
- 9- Fill in the blanks for- IP address: 192.168.1.35
Subnet mask: 255.255.0.0 "Use 'Space' button to skip the tab"
Default gateway: 192.168.1.1
- 10- Click "OK"

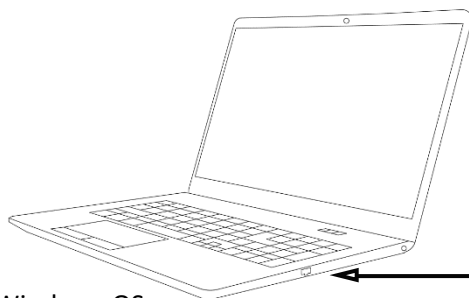
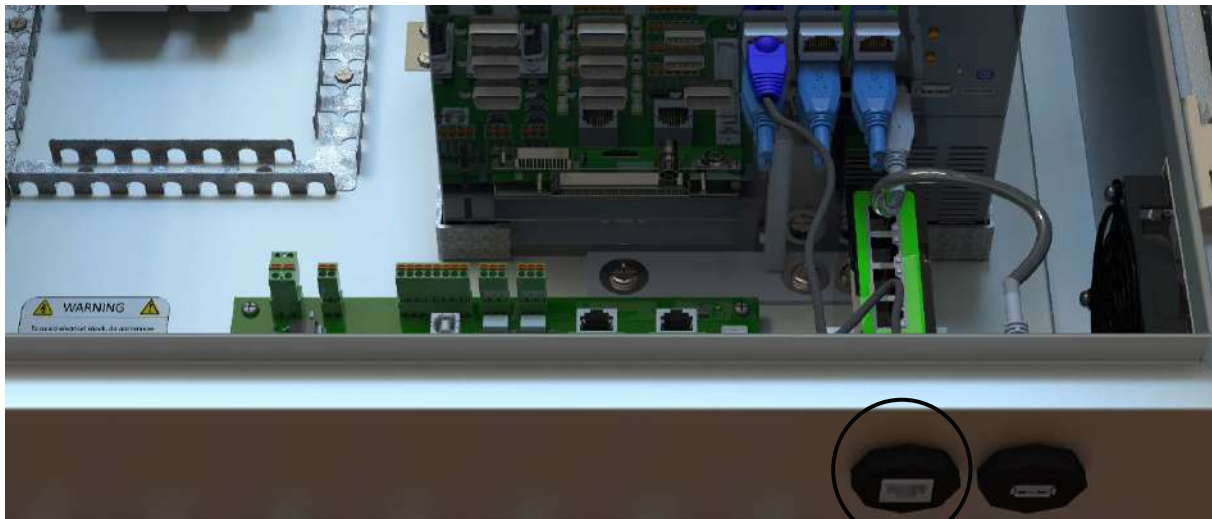

Plug-in here

LAN cable

Windows OS
Computer

Follow below steps to install the VDR application.

Download the application file by using download link. Open zip file and double click on OceanVoyager VDR Setup 1.1.0.exe.zip setup file.

If no download link exists, please contact with technic@oceanvoyagermarine.com

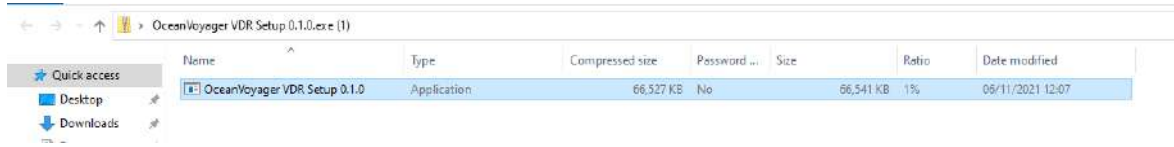

After clicking on installation file, the window below pops up. Click on 'More info' text.





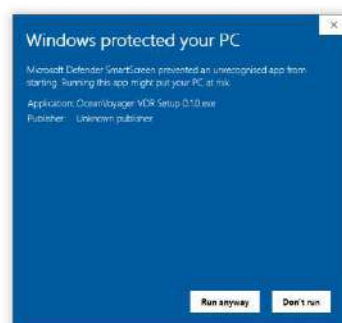

And then click on Run anyway. After few seconds, the application will be installed on PC.



Open the installation folder on pc.

Double click on OceanVoyager VDR.exe application file to start application.

	LICENSE.electron.txt	24.11.2021 17:09	Metin Belgesi	2 KB
	LICENSES.chromium.html	24.11.2021 17:09	Microsoft Edge H...	4.606 KB
	OceanVoyager VDR.exe	24.11.2021 17:09	Uygulama	123.249 KB
	resources.pak	24.11.2021 17:09	PAK Dosyası	4.899 KB

If no folder found than click on windows button on keyboard and go to search box, type 'VDR' on the searching box.

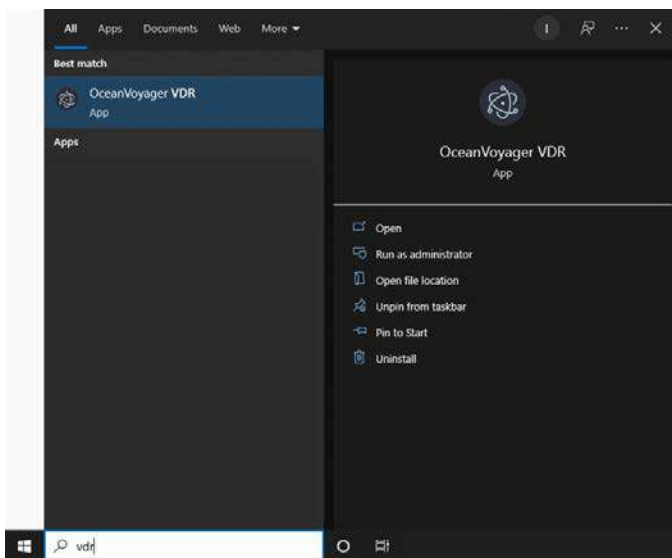

Click on VDR application symbol to start the application.

On the first page write username and password to log in to the application.

If no username or password applicable, please contact with technic@oceanvoyagermarine.com



Homepage;

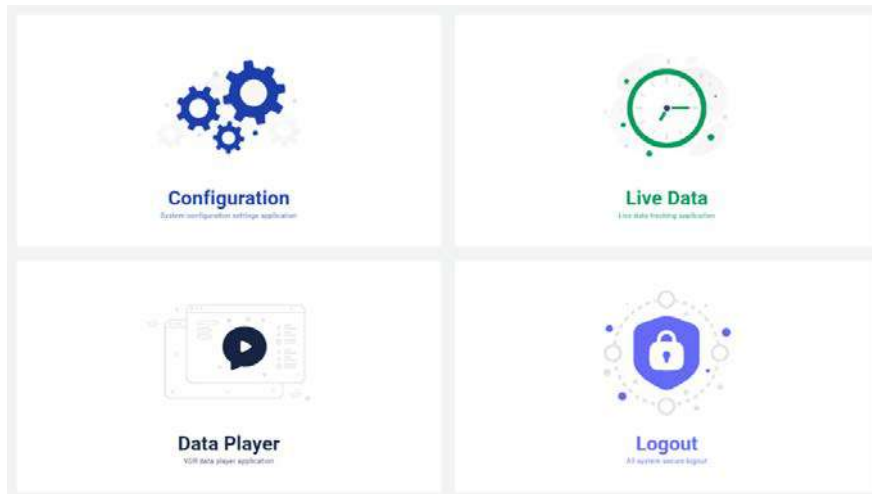

VDR app can be used for to view live data, apply configuration changes, download, and display recorded data by connecting a proper computer. When proper connection done with LAN cable, computer will be successfully connected to DAU or any capsule. For to connect to DAU, FFC or FPC use LAN port which located under the DAU panel. Use the LAN cable to make connection. Use proper IP setting to connect DAU successfully. To do that, apply IP settings that indicated above.

2.3.2 Live Data

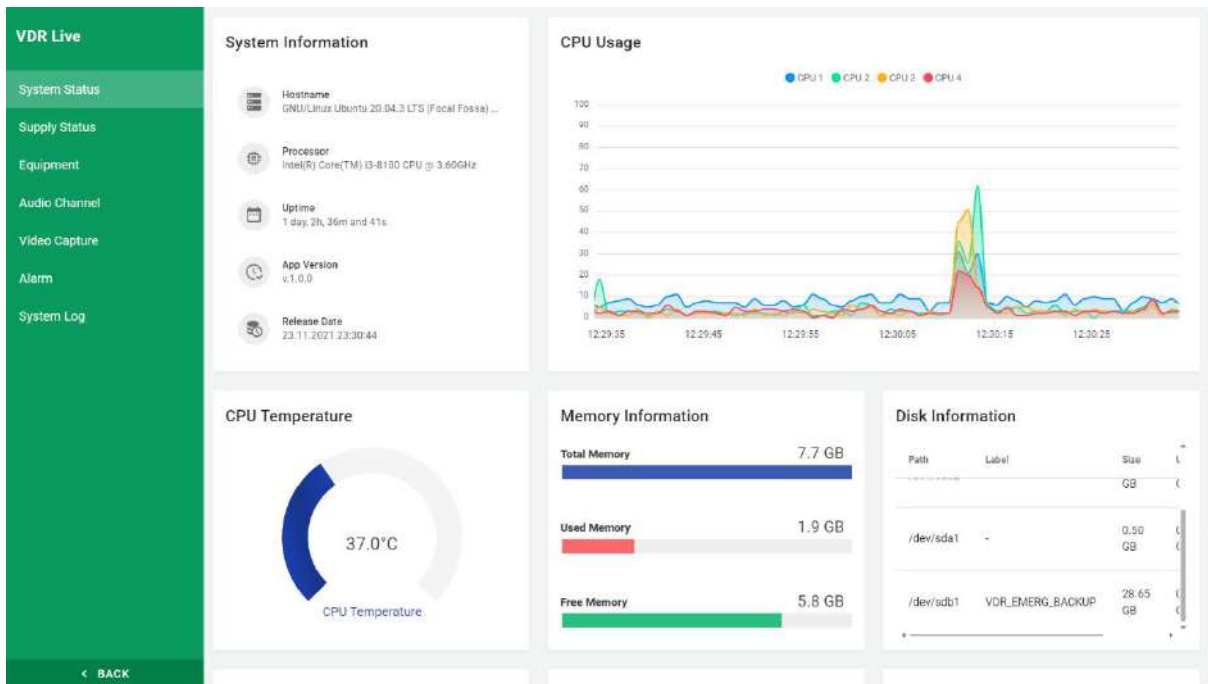

2.3.2.1 System Status

System load on the processor can be viewed in this page. The memories display here are belong to Data Acquisition Unit (DAU).

DAU temperature and fan speeds can be viewed in this page.

To view fan speeds, scroll down the page.

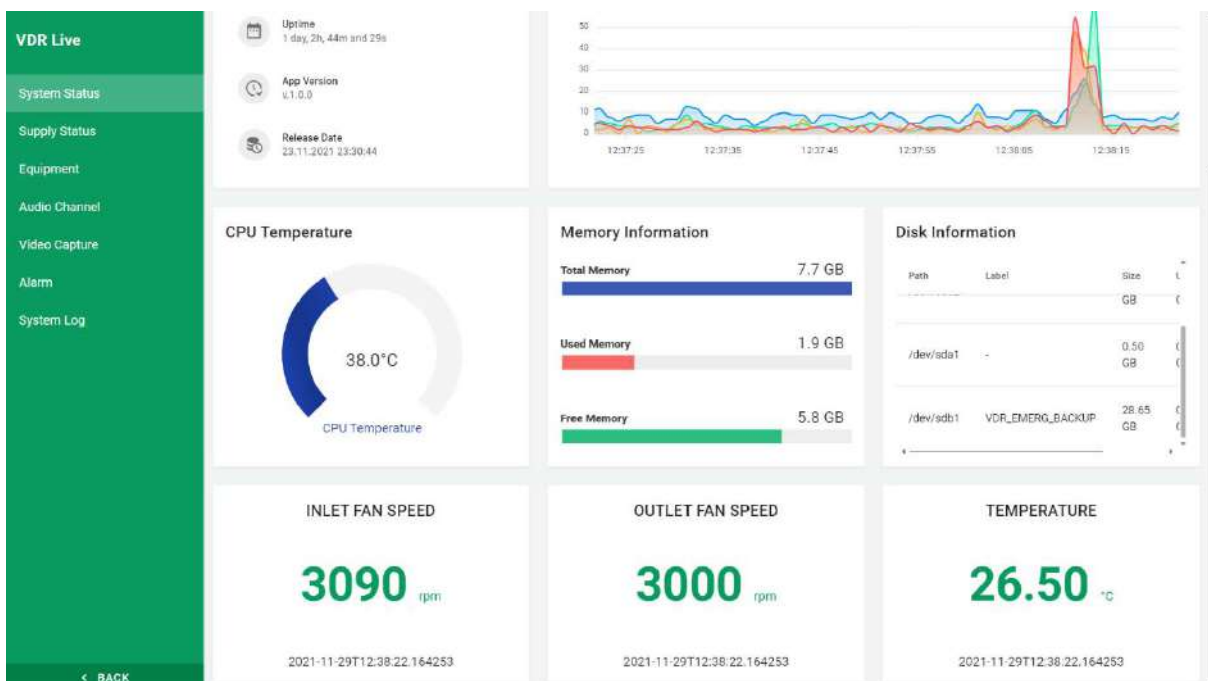

2.3.2.2 Supply Status

This page shows the status of power supply. If there is loss of DC voltage or run out of battery situation, indicators show it. The alarms display on the RAP simultaneously. The time under any icon indicates the exact time for last status.

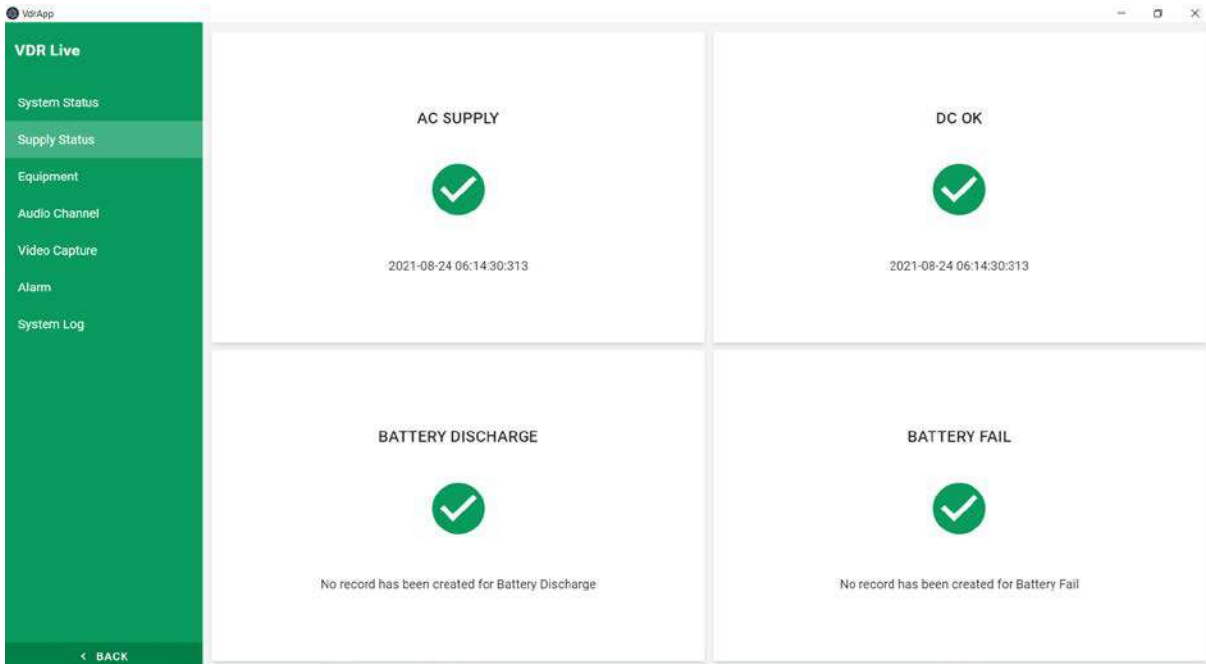

In case any error occurs, there will be fail sign as showed below. In this case there is no AC supply power and system is running by the batteries. Batteries discharging and no external power supplied. The time that AC power failure occurred indicated below the failure icon.

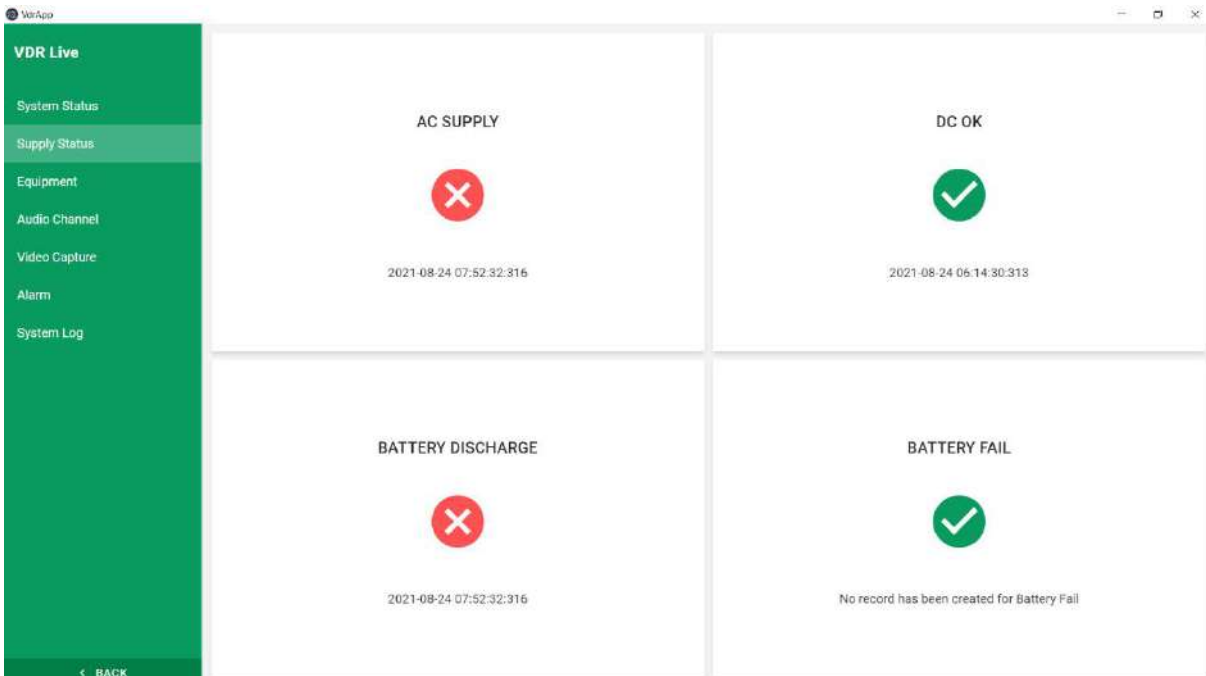

2.3.2.3 Equipment

This page shows real time data flow received from connected equipment's. To see the data flows, click on each specified tab. Be aware that data displays here are simultaneously. Use this tab after installation to see whether data received correctly or not. Check this data flow after every equipment connection.

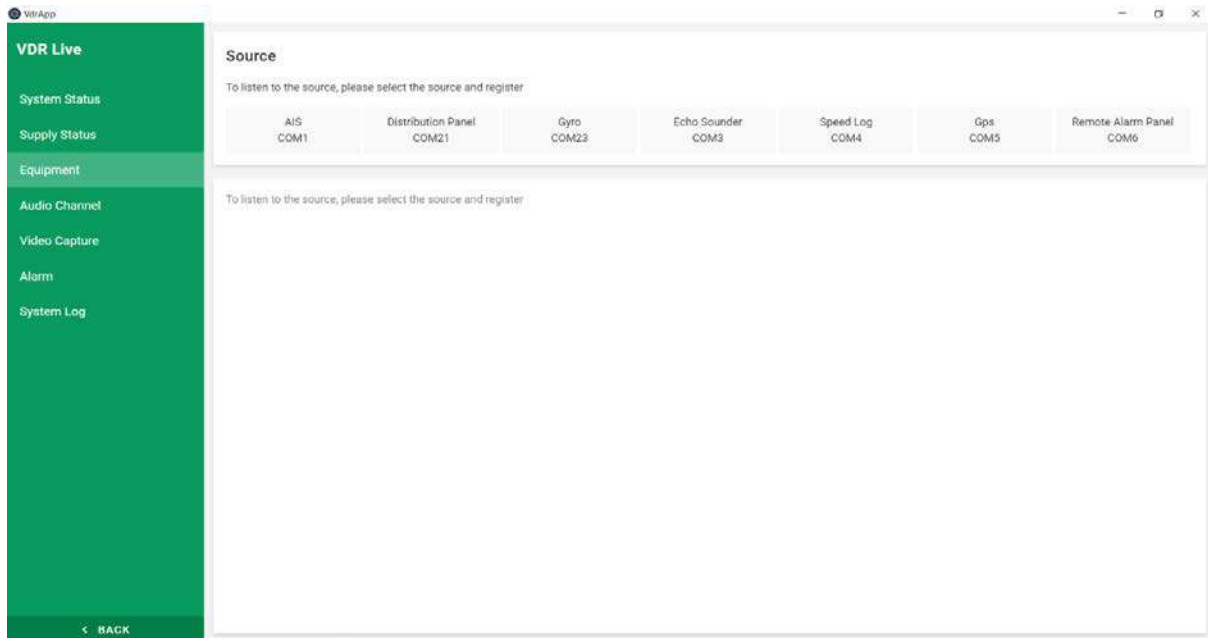

When clicked on the specified tab window below displays. On distribution panel (DISPAN) tab, logs received from DISPAN can be viewed. Flowing sentences indicates that connection is stable with the processor.

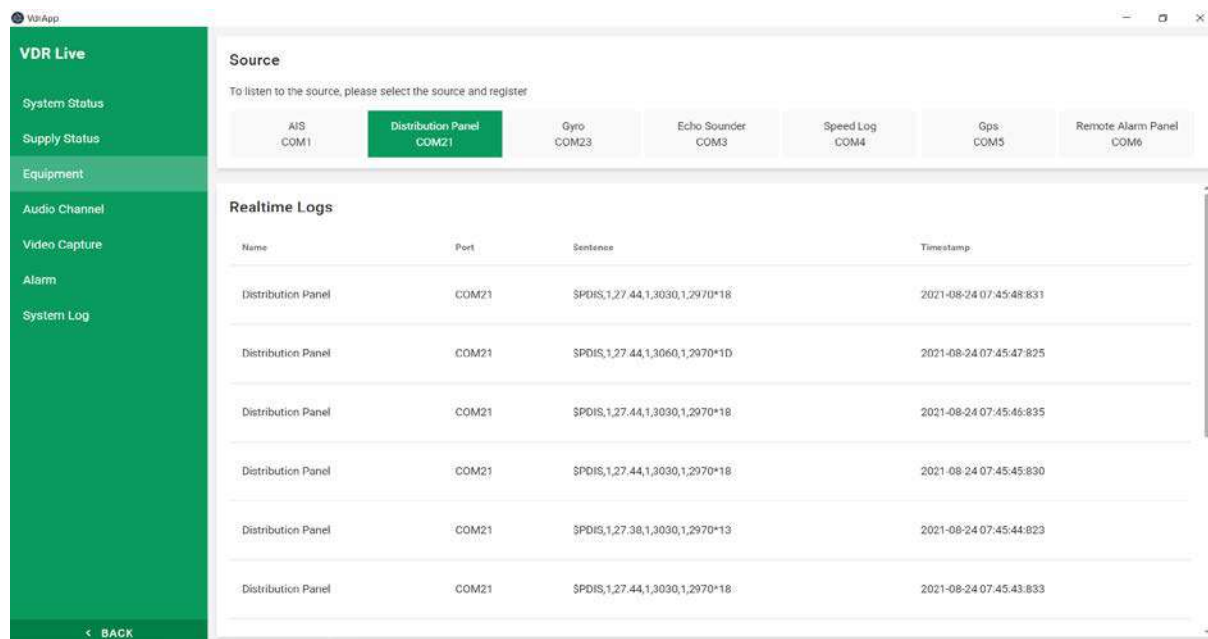

In this tab remote alarm panel and DAU communication sentences are displaying. No alarm displays here. These sentences indicates that RAP cable connection running properly.

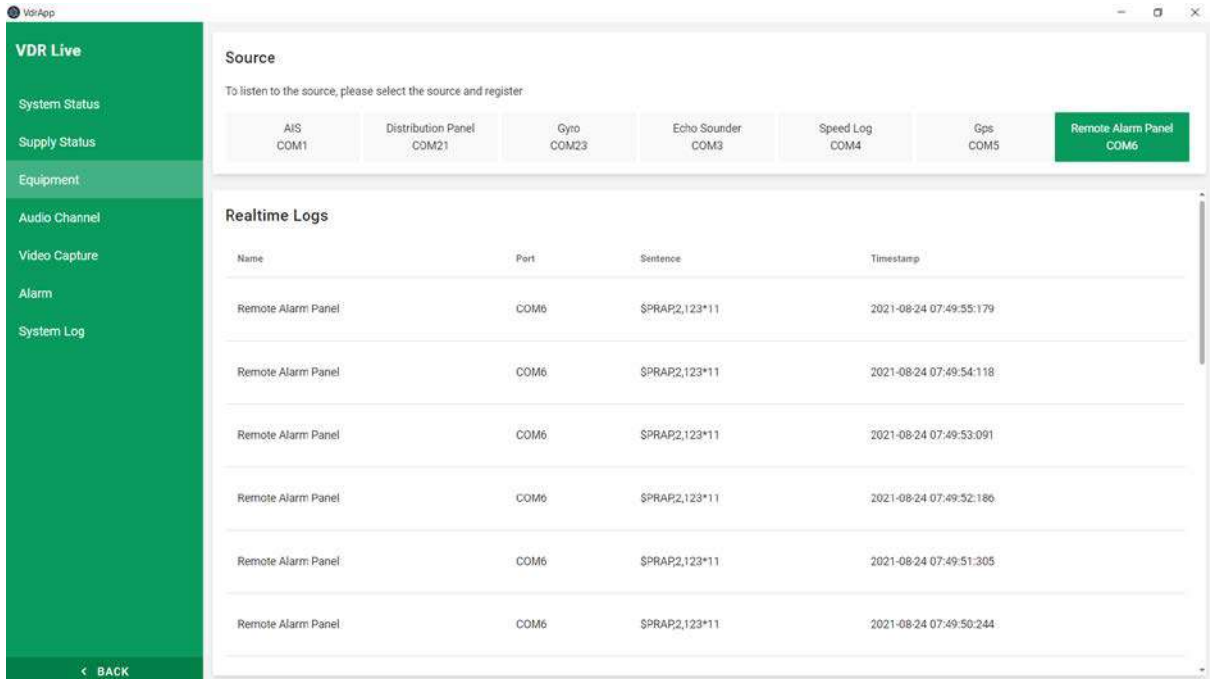

AIS data sentences flows simultaneously in this tab. Realtime data from AIS displays here as sentences.

If there are no sentence here, check serial data cable connections and related device.

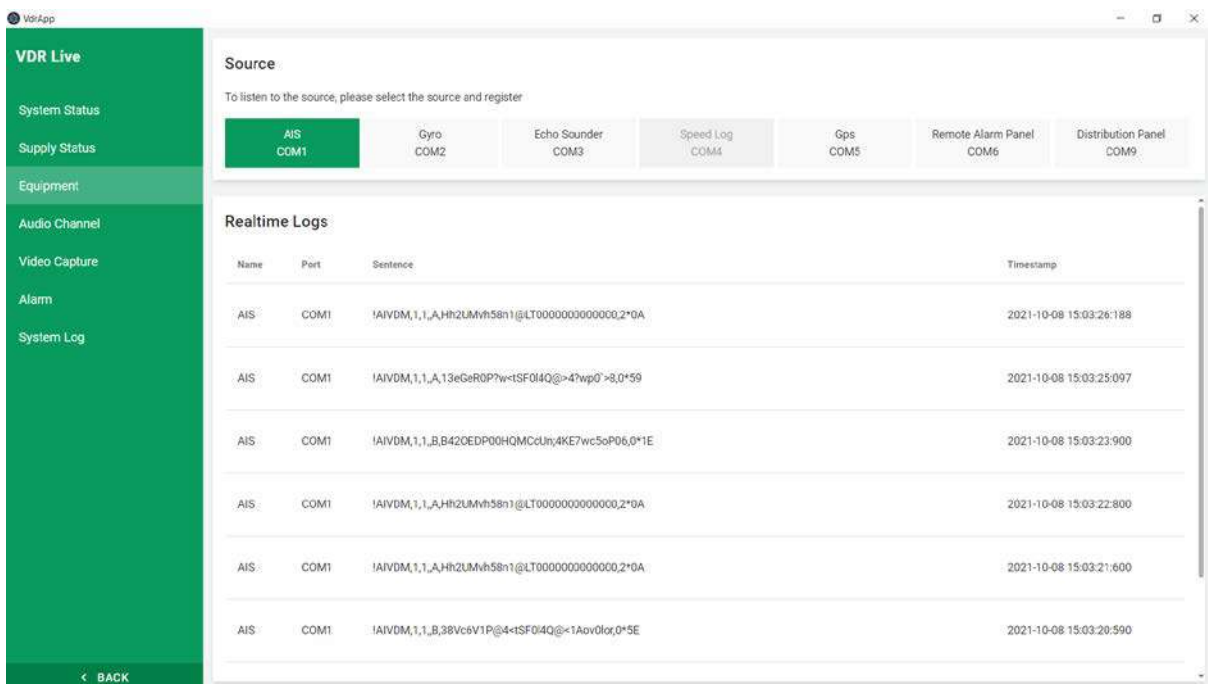

Gyrocompass data sentences flows simultaneously in this tab. Realtime heading data sentences displays here. These sentences indicates that gyrocompass running properly and transmits data to S-VDR. If there are no sentence here, check serial data cable connections and related device.

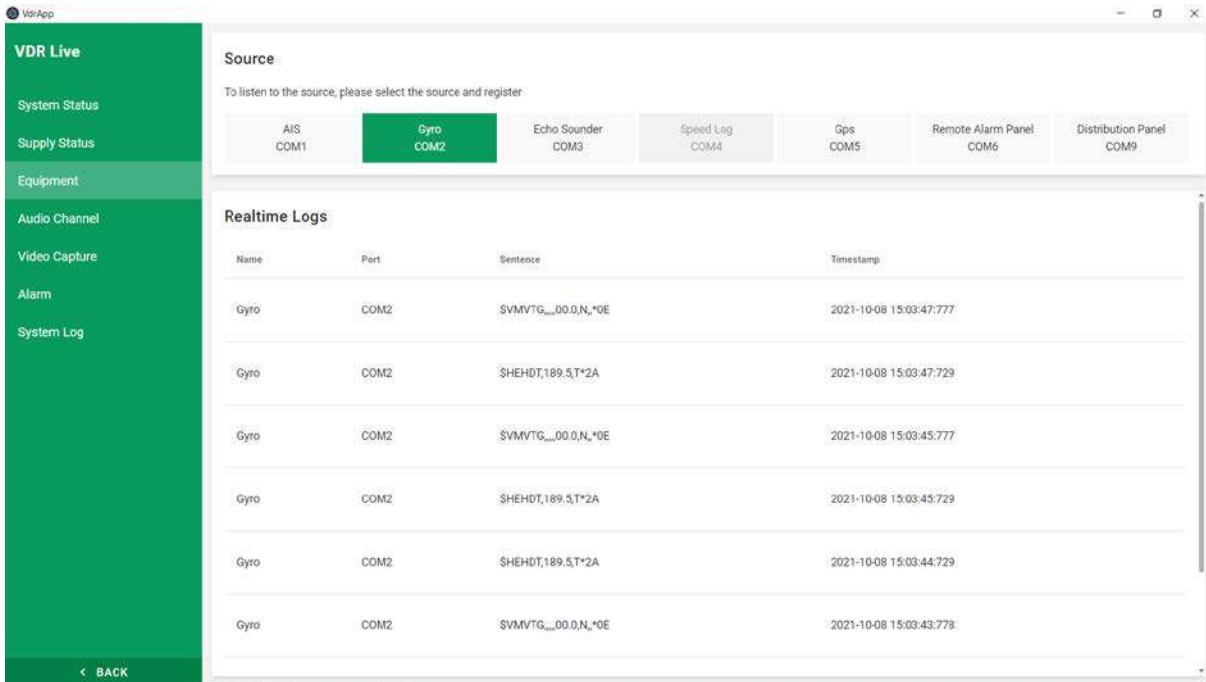

Echo sounder data sentences flows simultaneously in this tab. Realtime echo sounder data sentences displays here. If the device connected to any other device, it also transmits that devices data. If there are no sentence here, check serial data cable connections and related device.

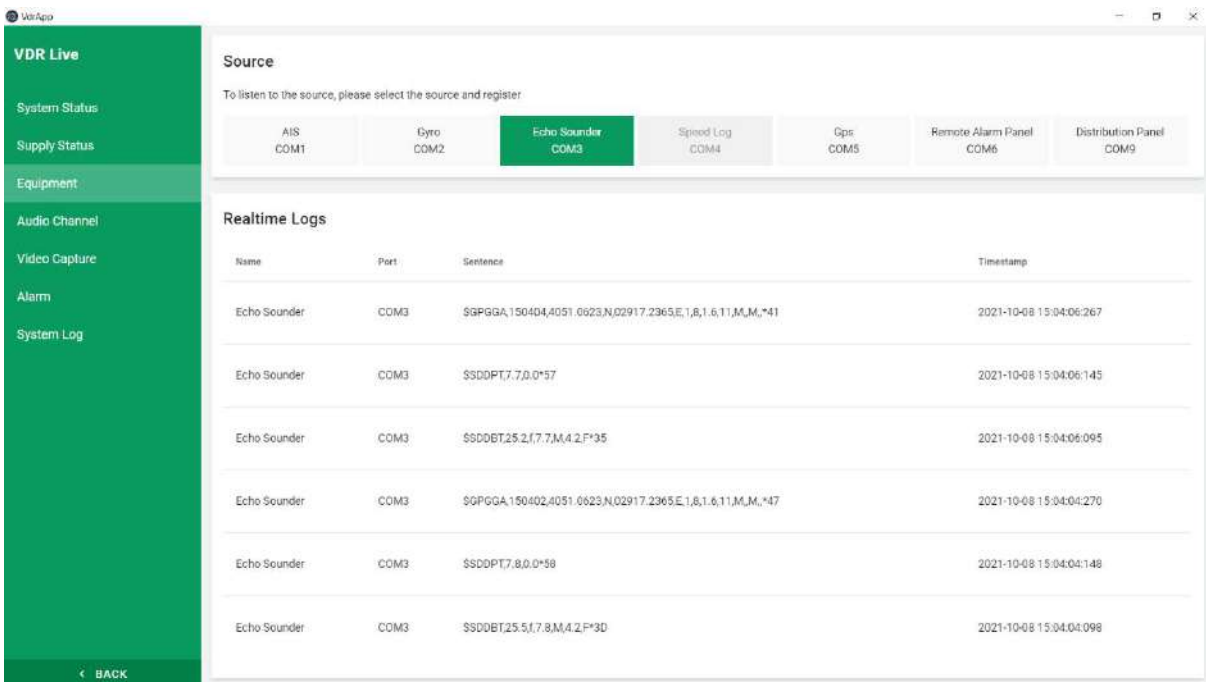

GPS data sentences flows simultaneously in this tab. Realtime GPS data sentences displays here. These sentences indicates that GPS running properly and transmits data to S-VDR. If there are no sentences check serial cable connections and related device.

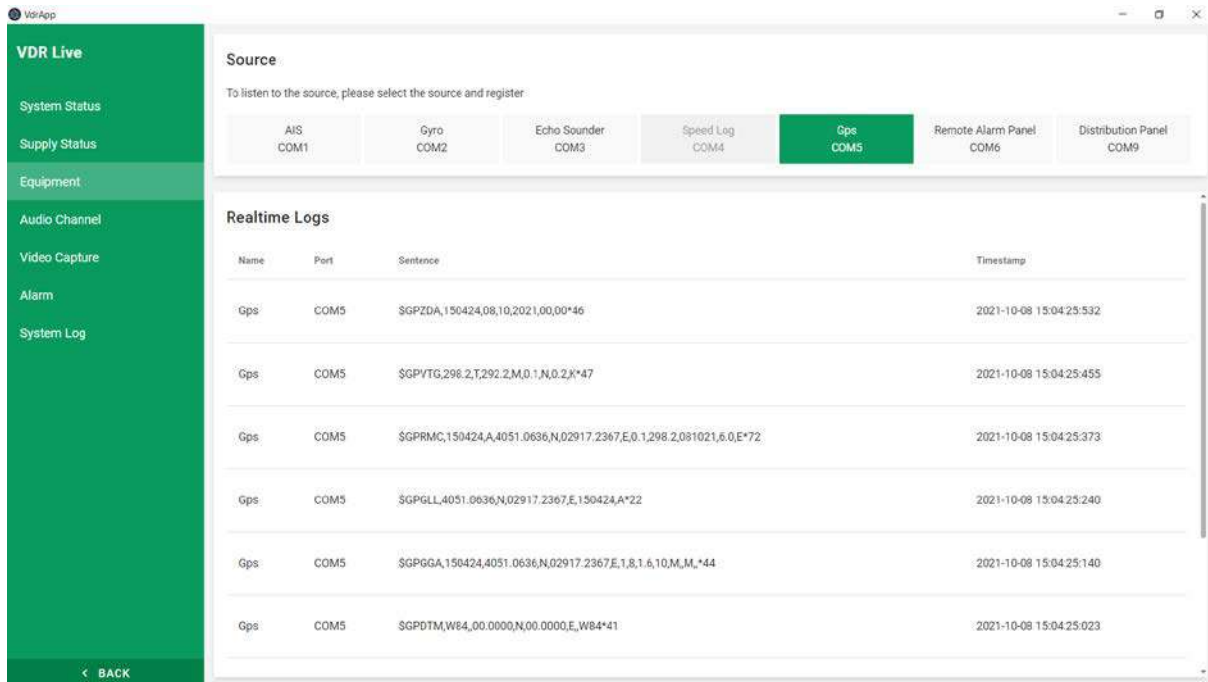

The screenshot shows the VDRApp interface. On the left is a green sidebar menu with options: VDR Live, System Status, Supply Status, Equipment, Audio Channel, Video Capture, Alarm, and System Log. The main area is titled 'Source' and contains a message: 'To listen to the source, please select the source and register'. Below this are seven buttons for different sources: AIS COM1, Gyro COM2, Echo Sounder COM3, Speed Log COM4, Gps COM5 (which is highlighted in green), Remote Alarm Panel COM6, and Distribution Panel COM9. Below the source selection is a 'Realtime Logs' section with a table of data.

Name	Port	Sentence	Timestamp
Gps	COM5	\$GPZDA,150424,08,10,2021,00,00*46	2021-10-08 15:04:25:532
Gps	COM5	\$GPVTG,298.2,T,292.2,M,0.1,N,0.2,K*47	2021-10-08 15:04:25:455
Gps	COM5	\$GPRMC,150424,A,4051.0636,N,02917.2367,E,0.1,298.2,091021,6.0,E*72	2021-10-08 15:04:25:373
Gps	COM5	\$GPGLL,4051.0636,N,02917.2367,E,150424,A*22	2021-10-08 15:04:25:240
Gps	COM5	\$GPGGA,150424,4051.0636,N,02917.2367,E,1,8,1.6,10,M,M,*44	2021-10-08 15:04:25:140
Gps	COM5	\$GPDTM,W84,00.0000,N,00.0000,E,W84*41	2021-10-08 15:04:25:023

2.3.2.4 Audio Channel

Audio tab can be used to listen live audio channels simultaneously. Microphone tests can be run, and results will be showed in few seconds. If there is an error in any audio channel, there will be an error sign right bottom corner of each tab and manual audio channel alarm displays on RAP. Microphones and VHF audio channels listed as displays on the screen below. Name of the channels can be changed on the configuration window.

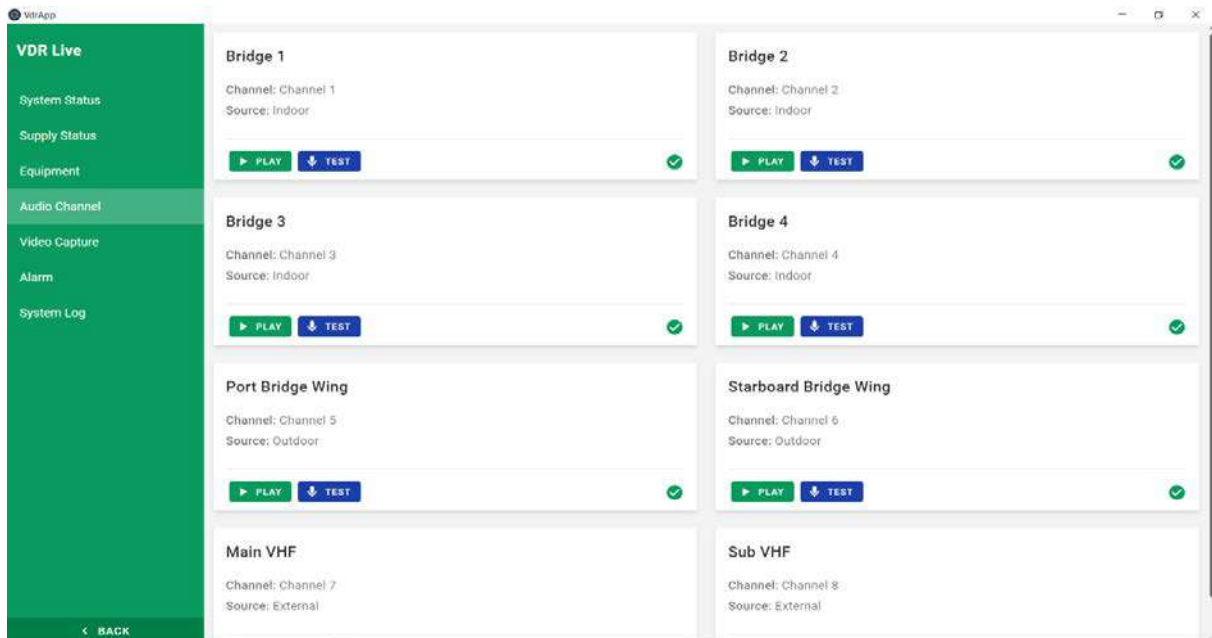

To listen any channel simultaneously click on the play button located on each tab. To finish listening click on the stop button. In the picture below 'Bridge 1' audio channel is in listening position. Green microphone sign means that this channel is in listening mode, but it does not mean that there is voice in this channel. Channels must be listened to confirm if the microphones recording audio.

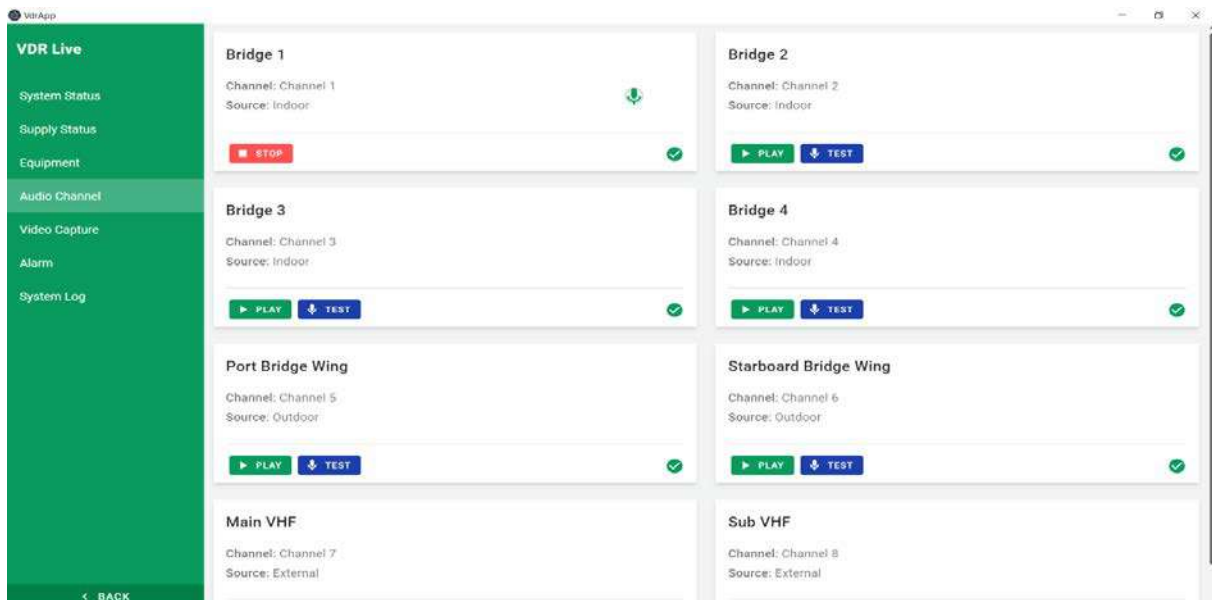

2.3.2.5 Video Capture

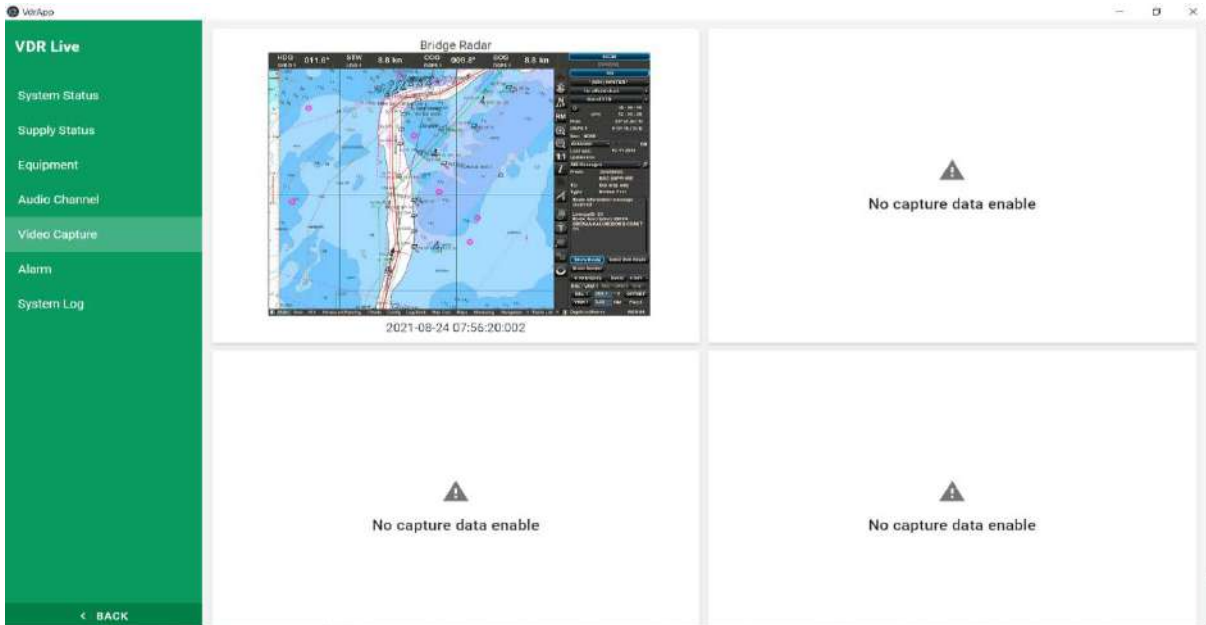

In this tab ECDIS and radar screenshots displays every 10 seconds. For S-VDR DR-100S up to 2 ECDIS and two radar screens can be recorded. In this page screenshots that displaying every 10 seconds can be viewed.

2.3.2.6 Alarm

In alarm tab the logs created by system processor are displaying. By making proper connection, live alarms can be viewed. If the alarms on RAP acknowledged there will be YES sign on the message tab.

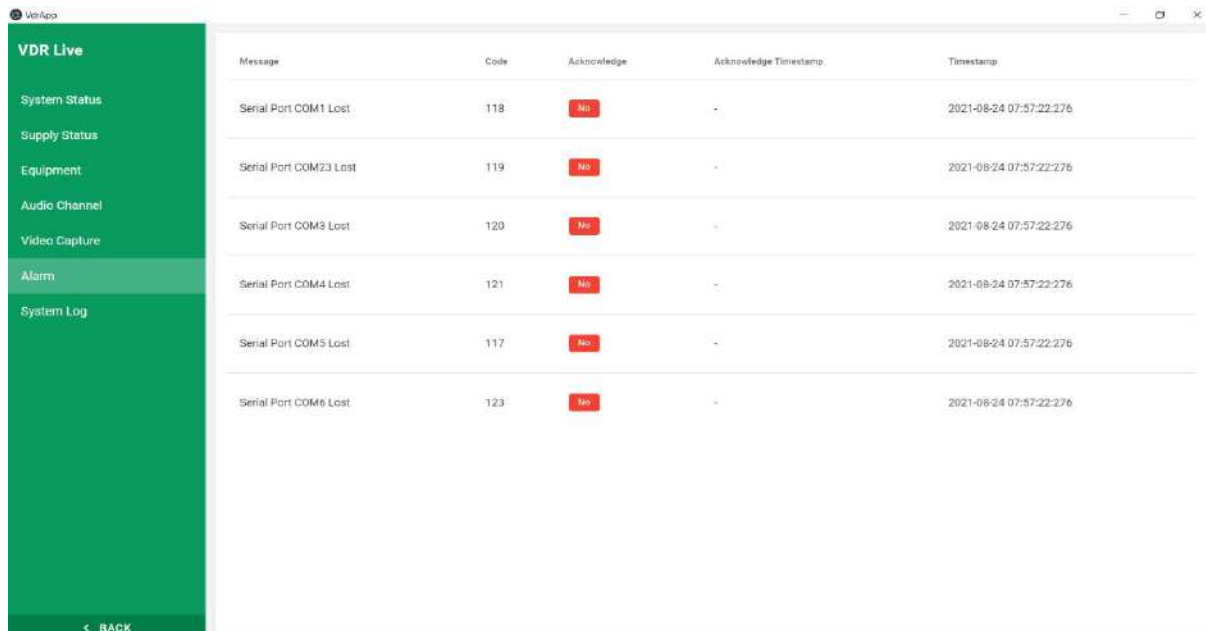

2.3.2.7 System Log

In system log tab all sentences received from any equipment can be viewed. All logs can be downloaded except capture device frames. To download frames, go to player tab filter the date and time click on export button.

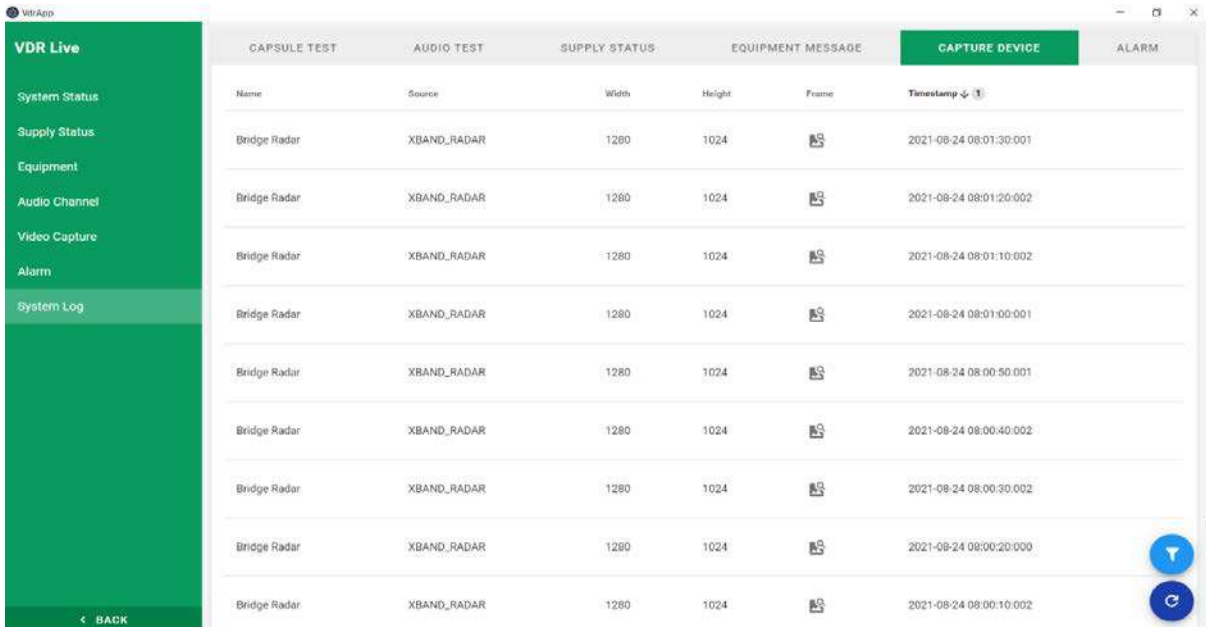

CAPSULE TEST	AUDIO TEST	SUPPLY STATUS	EQUIPMENT MESSAGE	CAPTURE DEVICE	ALARM
Name	Source	Width	Height	Frame	Timestamp ↓ ↑
Bridge Radar	XBAND_RADAR	1280	1024	AS	2021-08-24 08:01:30:001
Bridge Radar	XBAND_RADAR	1280	1024	AS	2021-08-24 08:01:20:002
Bridge Radar	XBAND_RADAR	1280	1024	AS	2021-08-24 08:01:10:002
Bridge Radar	XBAND_RADAR	1280	1024	AS	2021-08-24 08:01:00:001
Bridge Radar	XBAND_RADAR	1280	1024	AS	2021-08-24 08:00:50:001
Bridge Radar	XBAND_RADAR	1280	1024	AS	2021-08-24 08:00:40:002
Bridge Radar	XBAND_RADAR	1280	1024	AS	2021-08-24 08:00:30:002
Bridge Radar	XBAND_RADAR	1280	1024	AS	2021-08-24 08:00:20:000
Bridge Radar	XBAND_RADAR	1280	1024	AS	2021-08-24 08:00:10:002

All other data can be filtered and downloaded by using the buttons. If there are new logs refresh the page to see them all. The page below shows the capsule connection. After mounting capsules make proper cable connection with DAU. Check this page if capsules started running or use this page for connection diagnostics.

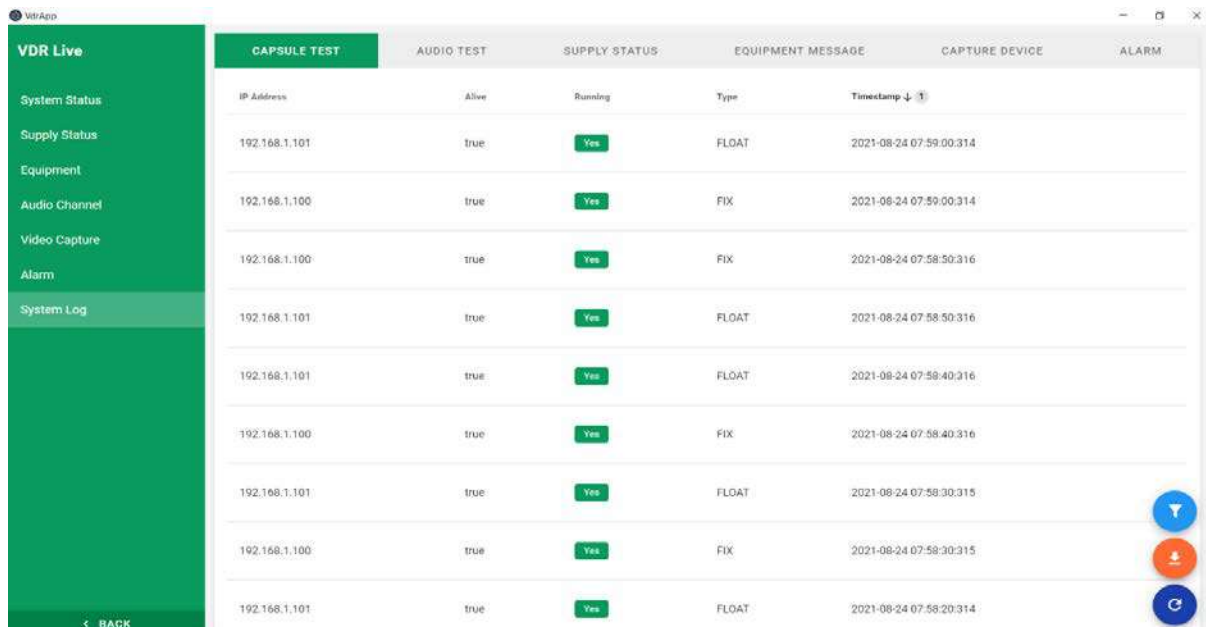

IP Address	Alive	Running	Type	Timestamp ↓ ↑
192.168.1.101	true	Yes	FLOAT	2021-08-24 07:59:00:314
192.168.1.100	true	Yes	FIX	2021-08-24 07:59:00:314
192.168.1.100	true	Yes	FIX	2021-08-24 07:58:50:316
192.168.1.101	true	Yes	FLOAT	2021-08-24 07:58:50:316
192.168.1.101	true	Yes	FLOAT	2021-08-24 07:58:40:316
192.168.1.100	true	Yes	FIX	2021-08-24 07:58:40:316
192.168.1.101	true	Yes	FLOAT	2021-08-24 07:58:30:315
192.168.1.100	true	Yes	FIX	2021-08-24 07:58:30:315
192.168.1.101	true	Yes	FLOAT	2021-08-24 07:58:20:314

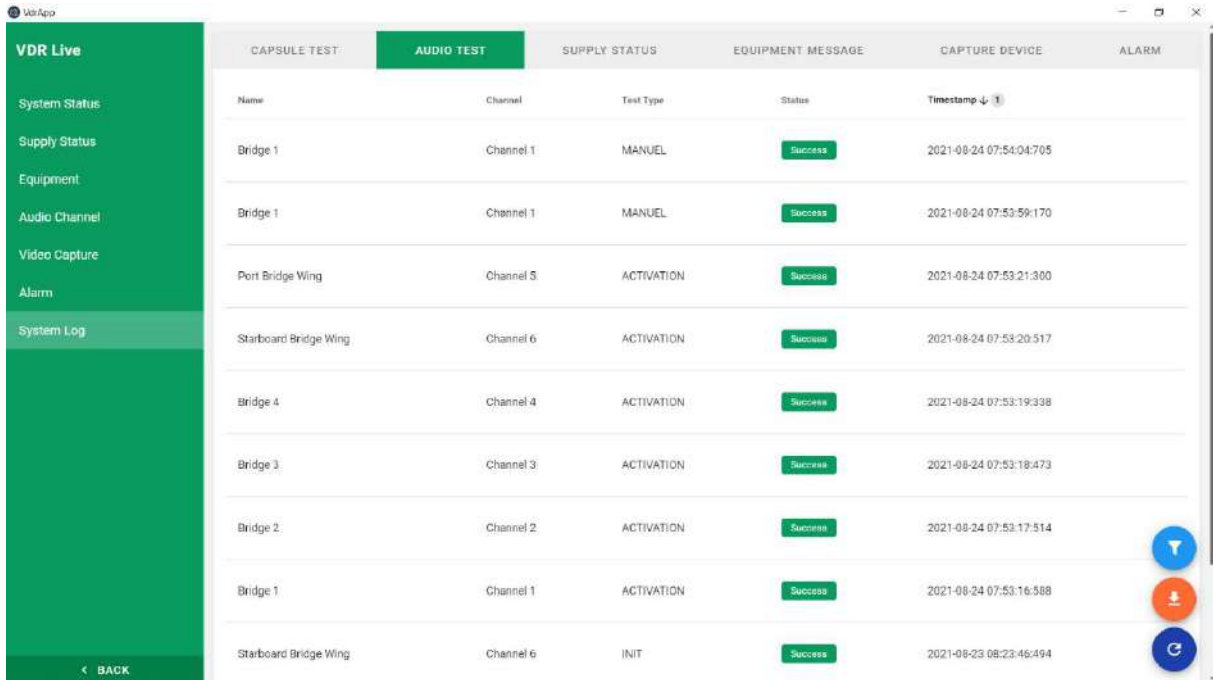

CAPSULE TEST		AUDIO TEST		SUPPLY STATUS	EQUIPMENT MESSAGE	CAPTURE DEVICE	ALARM
Name	Channel	Test Type	Status	Timestamp ↓ 1			
Bridge 1	Channel 1	MANUEL	Success	2021-08-24 07:54:04:705			
Bridge 1	Channel 1	MANUEL	Success	2021-08-24 07:53:59:170			
Port Bridge Wing	Channel 5	ACTIVATION	Success	2021-08-24 07:53:21:300			
Starboard Bridge Wing	Channel 6	ACTIVATION	Success	2021-08-24 07:53:20:517			
Bridge 4	Channel 4	ACTIVATION	Success	2021-08-24 07:53:19:338			
Bridge 3	Channel 3	ACTIVATION	Success	2021-08-24 07:53:18:473			
Bridge 2	Channel 2	ACTIVATION	Success	2021-08-24 07:53:17:514			
Bridge 1	Channel 1	ACTIVATION	Success	2021-08-24 07:53:16:588			
Starboard Bridge Wing	Channel 6	INIT	Success	2021-08-23 08:23:46:494			

All tests ran by user and the tests that system itself ran while starting the system can be seen and downloaded from this page.

In capsule tab Alive-True means; DAU system successfully connected to the capsule.

Running-Yes means; the operating system in capsule is running.

In audio test tab Status-Success means; microphone is recording successfully.

2.3.3 Player

This section is for to view and download the stored data in capsules and DAU. To view all data, click on the player tab first. Choose an option, import a downloaded file, or connect any recording medium.

For to play downloaded data from USB backup disc, DAU, FPC, or FFC click import and choose the downloaded file to play.

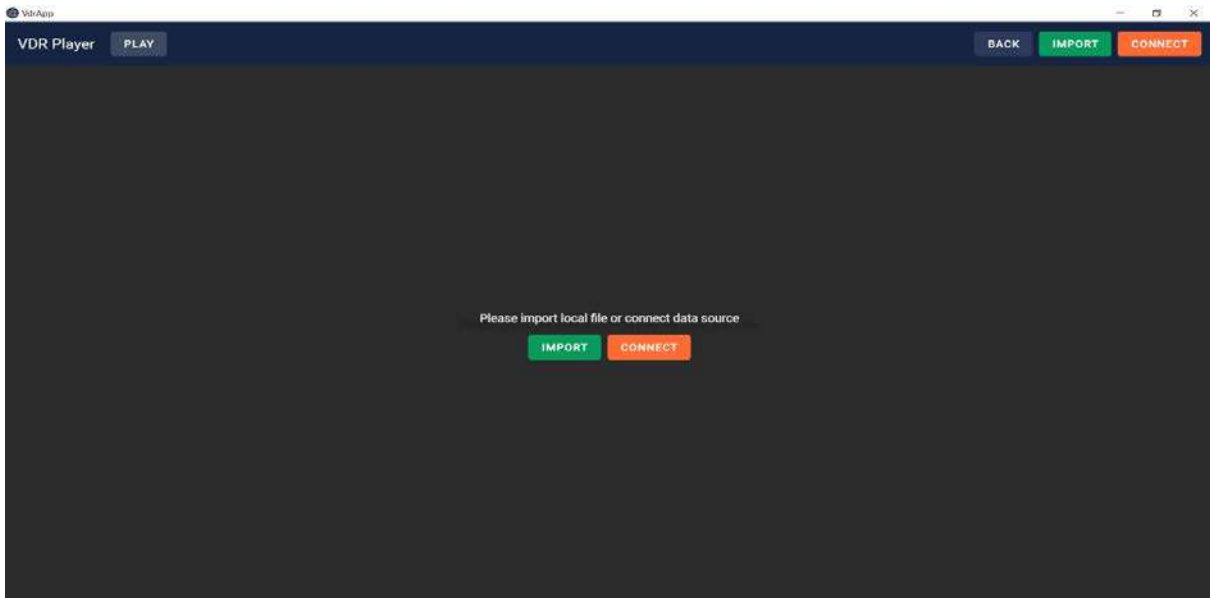

The page above displays on the screen. Click on the connect button to display or download the recorded data. Choose any storage to connect. When any capsule selected make sure LAN cable plugged in the port under the DAU. If DAU storage selected make sure the LAN cable plugged in the DAU connection port which located under the DAU panel. Live data and VDR app player connection available from same port under the DAU panel.

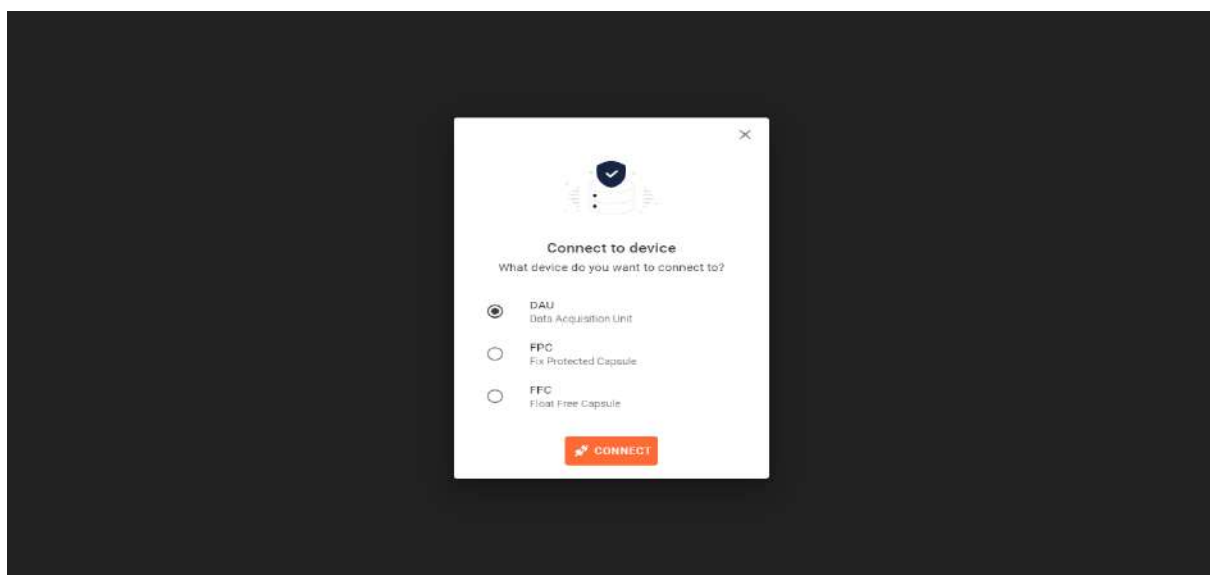

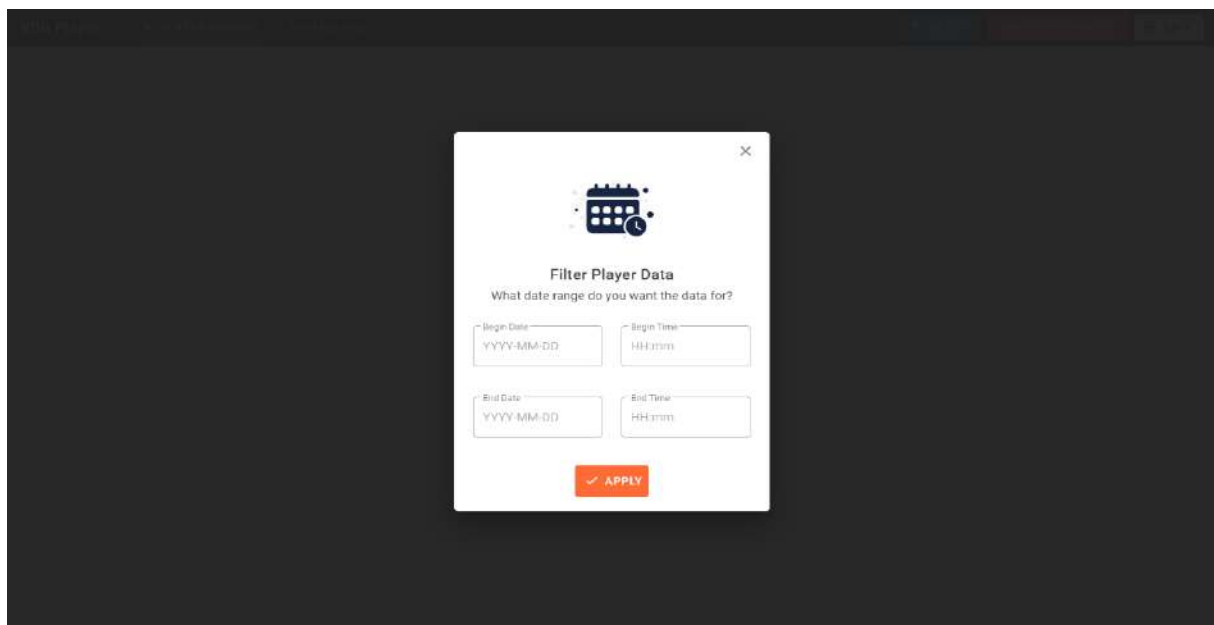
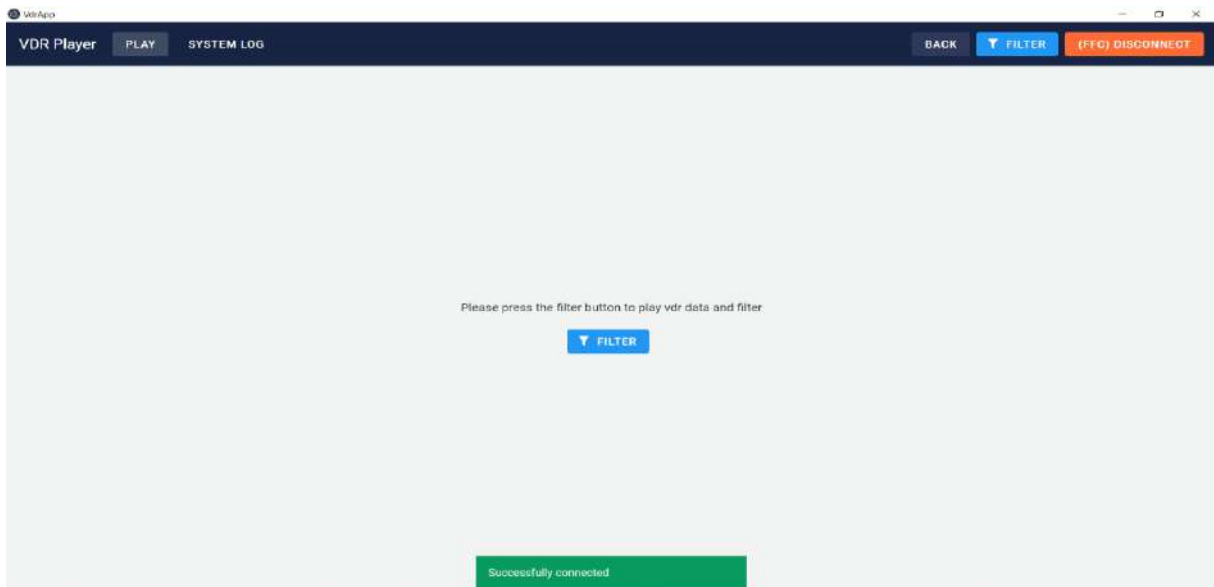
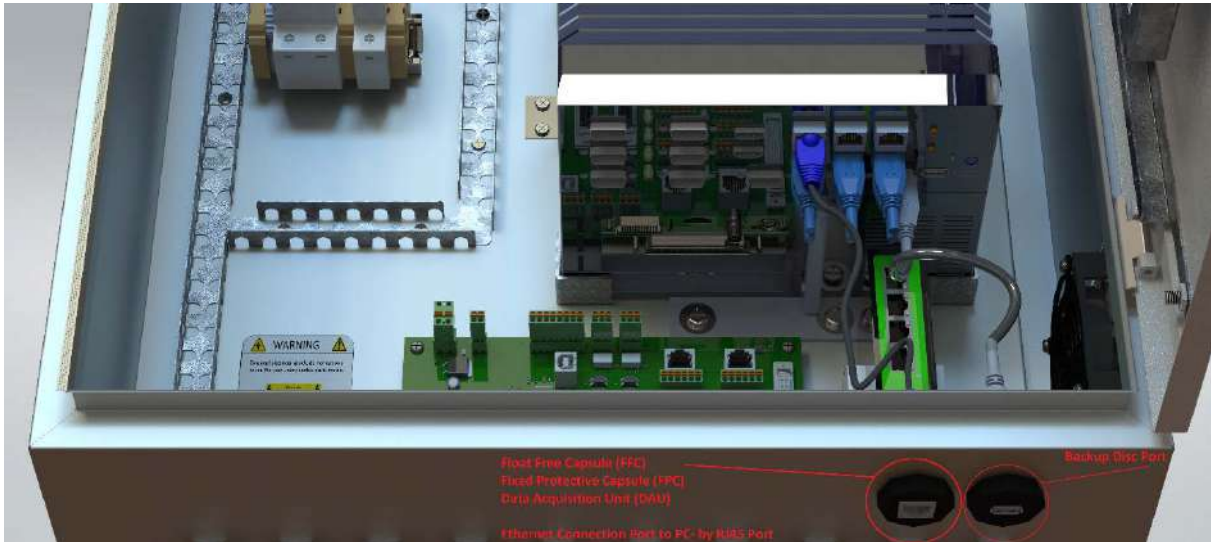

After clicking on the connect button the date and time selecting window displays. Select the exact date and time to listen, view and download. After selecting the date and time screen below pops up. To download the data, click on the export button and save the data. It takes about 1 minute to connect to the storage if 12 hours data will be downloaded. Wait until all data downloaded then unplug LAN connection. It approximately takes 45 minutes to download 12 hours data.

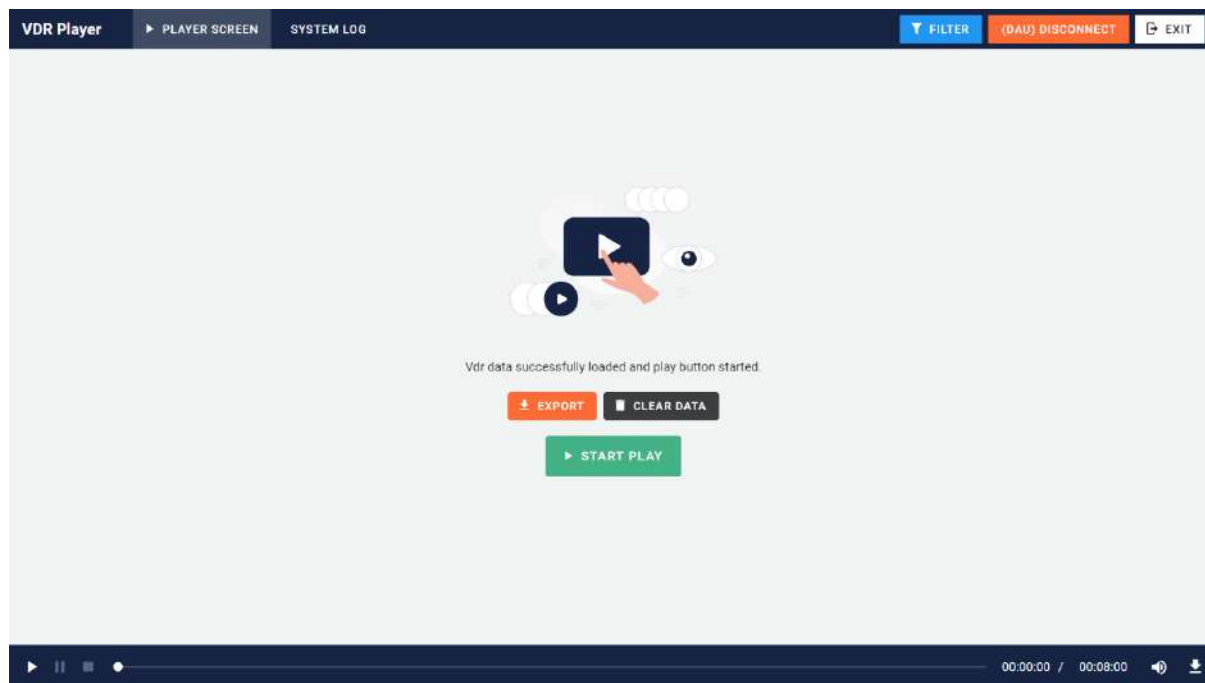

If all data wish to be viewed click on the start play button. After clicking the start play button the page below displays. If 12 hours data will be downloaded make sure last 12 hours selected. Make sure data exported with no error. Carefully choose the folder to save the 12 hours data on PC.

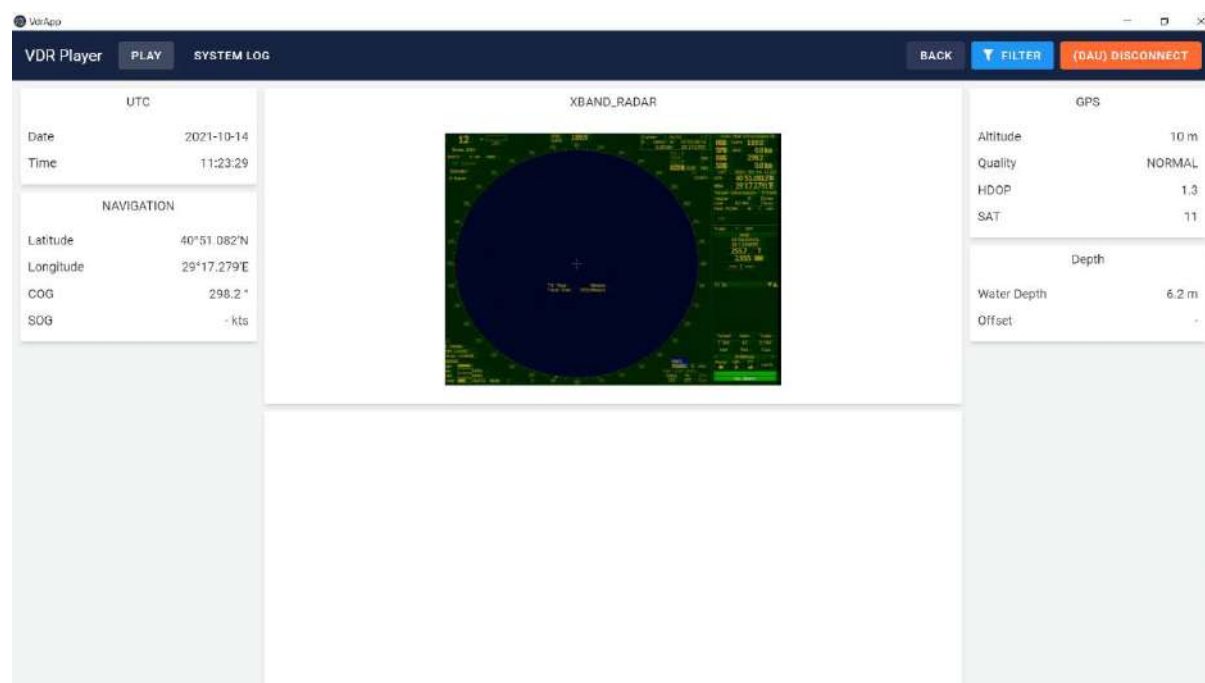

If play tab clicked scroll down the page, channel player buttons display. When connected to the storage audio channel player automatically starts. Skip to the exact time by using player cursor. To see logs recorded at that time click on the system log tab.

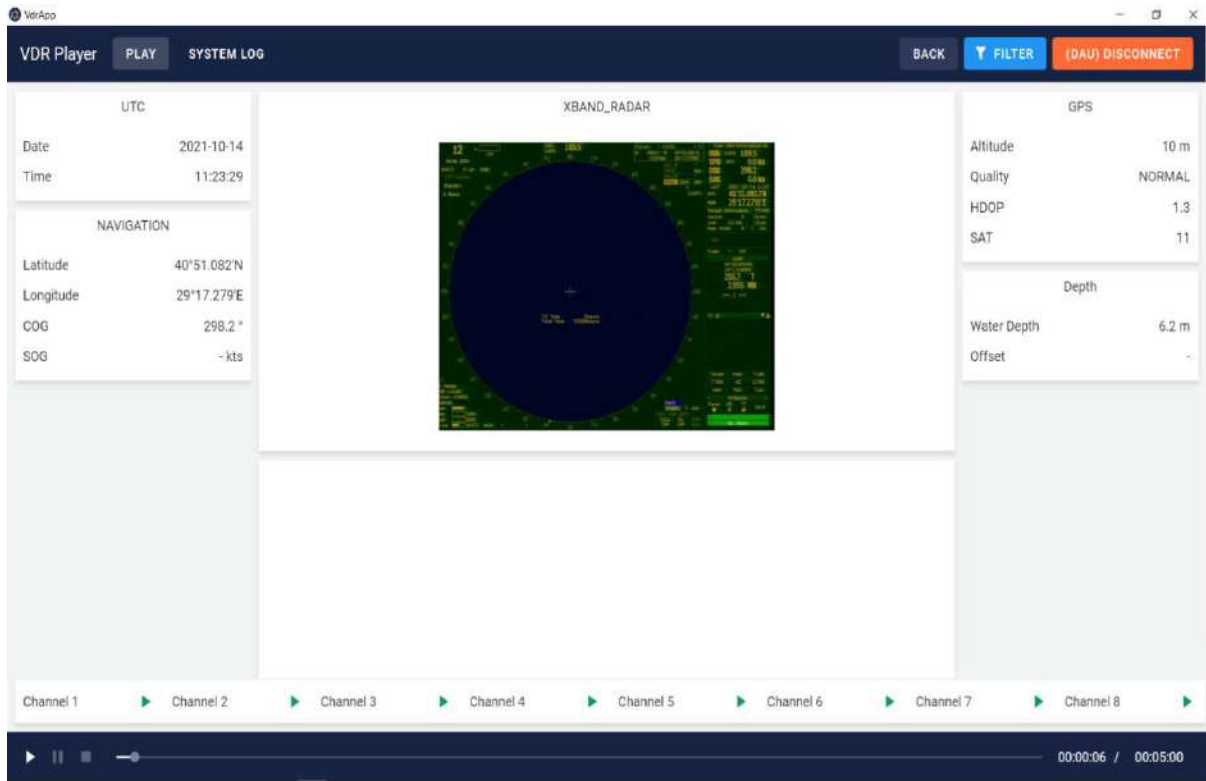

Click on the channel play button and it starts playing simultaneously.

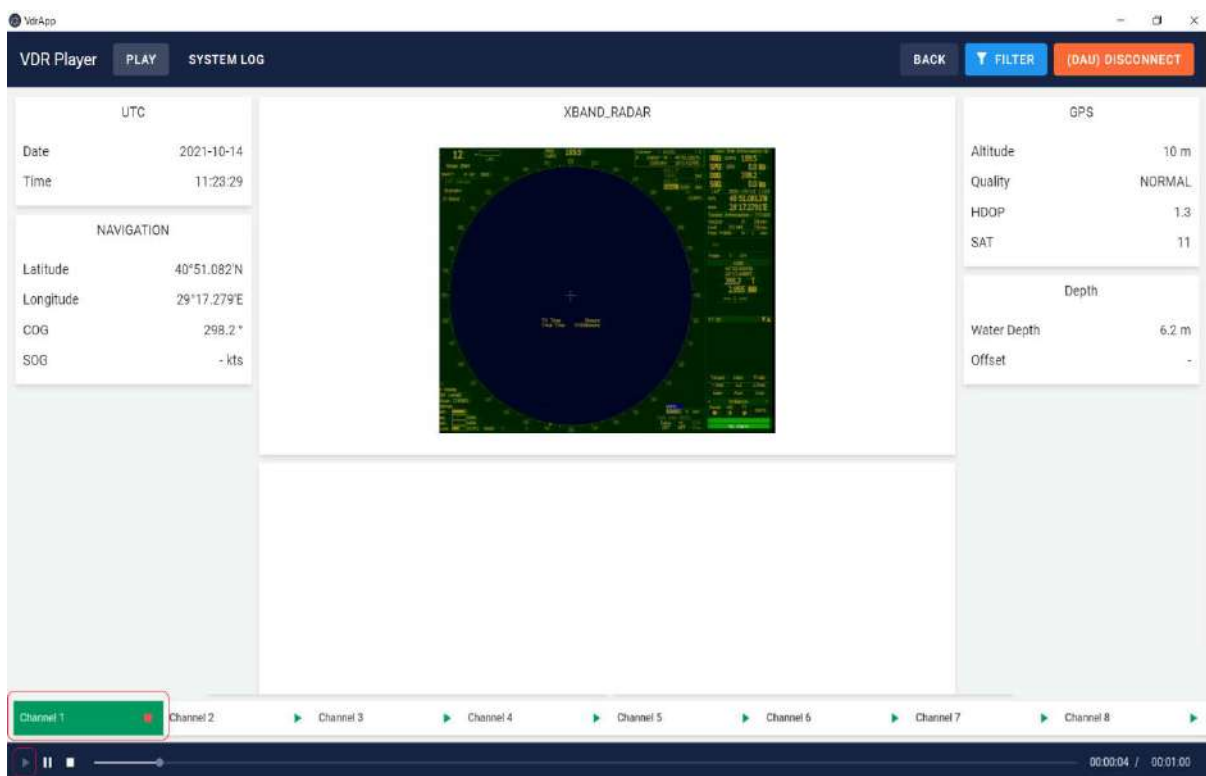

For to stop playing downloaded data click on the pause button.

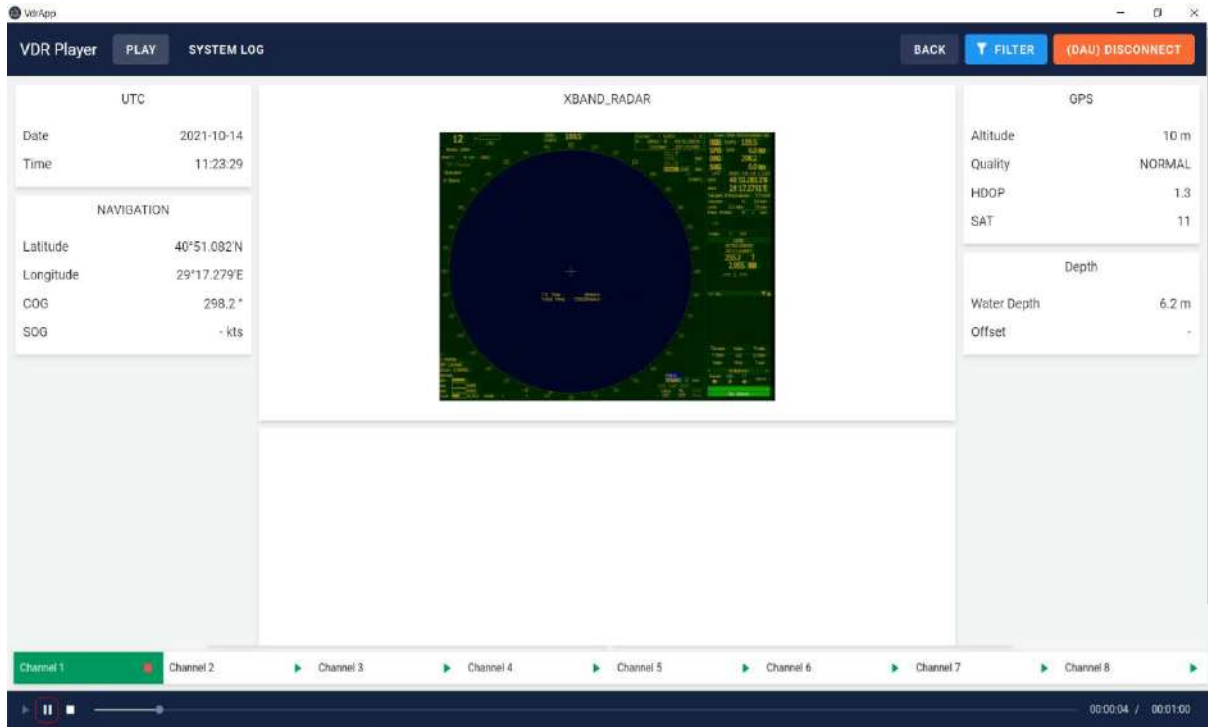

Click on the system log tab for to view system logs. In this window screenshots from radar and ECDIS are displaying. Date, time, longitude, latitude, course over ground and speed over ground can be inspected. By using AIS map other vessels can be viewed. Vessels can be seen by IMO numbers.

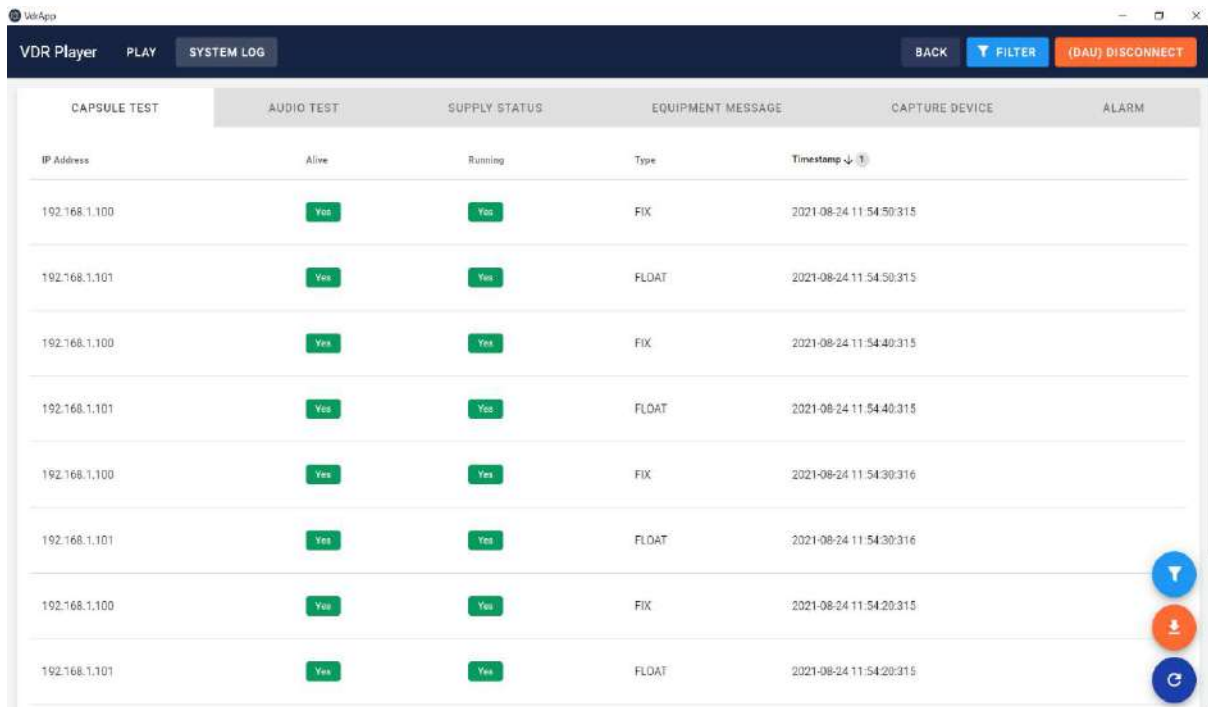

For to view the screenshots from RADAR/ECDIS click on the capture device tab. In this tab click on specified buttons to open frames as shown below.

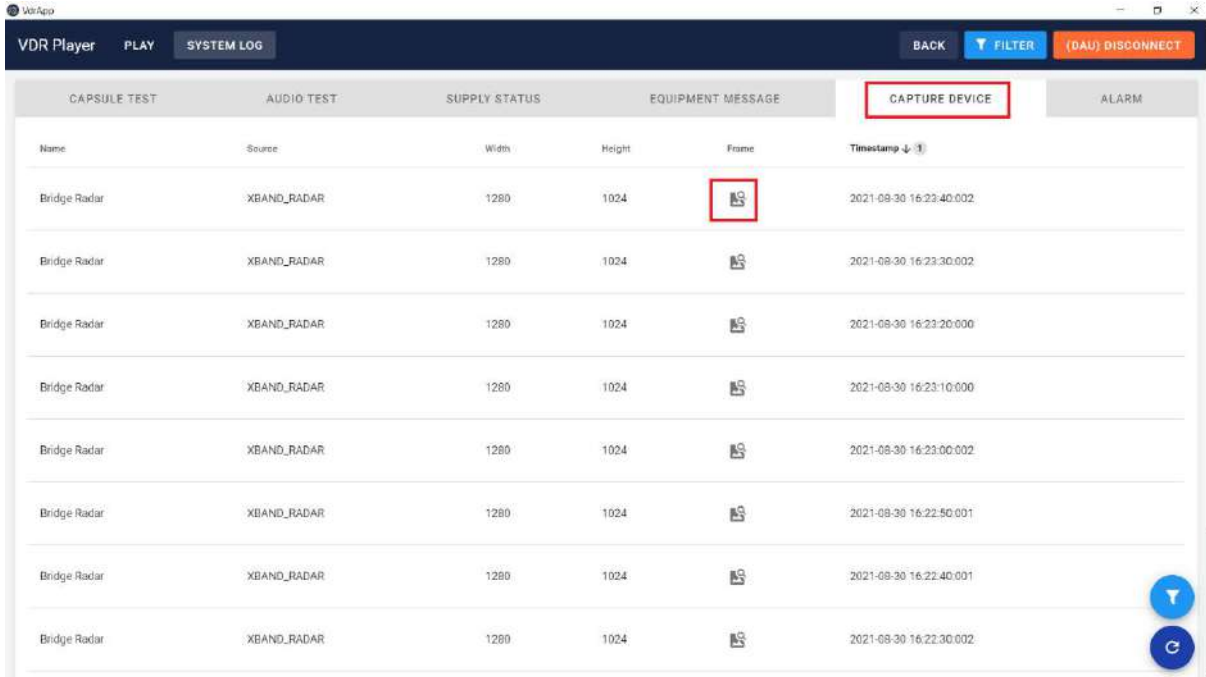

When clicked on the show frame button the page below displays. In this screen the frame can be inspected by zooming in and out.

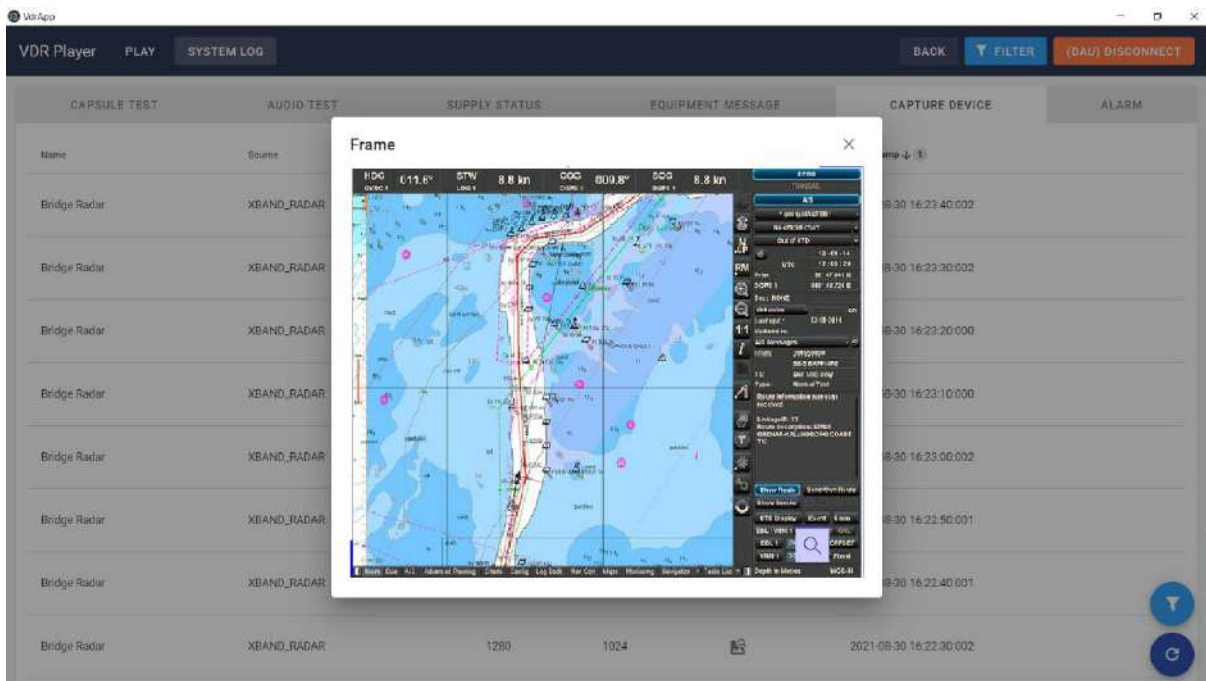

To download the system logs, click on the system log tab. Filter the date and time by clicking on filter button and click on the download button to download the results.

DR-100S S-VDR CABLE CODES

NO	CABLE
W1001	Ship's Mains 100-240VAC
W1002	Spare
W1003	Spare
W1004	Spare
W1005	AIS Data from Ship's AIS
W1006	Heading Data from Ship's Gyro
W1007	Depth Data from Ship's Echo Sounder
W1008	Speed Data from Ship's Log
W1009	GPS Data from Ship's GPS
W1010	RAP Data between RAP and DISPAN
W1011	Spare
W1012	Spare
W1013	Mic-1 Voltage and Audio Data
W1014	Mic-2 Voltage and Audio Data
W1015	Mic-3 Voltage and Audio Data
W1016	Mic-4 Voltage and Audio Data
W1017	Mic-5 Voltage and Audio Data
W1018	Mic-6 Voltage and Audio Data
W1019	VHF-1 Audio
W1020	VHF-2 Audio
W1021	Fixed Capsule Voltage and Data
W1022	Floating Capsule Voltage and Data
W1023	Spare
W1024	Spare
W1025	Radar Video Data
W1026	ECDIS Video Data
W1027	RJ45 for Remote PC
W1028	USB for Emergency Back-Up
W1029	Spare
W1030	Data Acquisition Card SCSI Cable

NO	CABLE
W1031	Fixed Capsule Data
W1032	Floating Capsule Data
W1033	Outlet and Inlet Fan's Control
W1034	Spare
W1035	AIS Data to PC
W1036	Heading Data to PC
W1037	Depth Data to PC
W1038	Speed Data to PC
W1039	GPS Data to PC
W1040	RAP Data to PC
W1041	PC Input Voltage 24VDC
W1042	Spare
W1043	DISPAN Input Voltage +24VDC
W1044	DISPAN Input Voltage GND
W1045	UPS Controller Unit Input Voltage +24VDC
W1046	UPS Controller Unit Input Voltage GND
W1047	Main DC OK Signal Contact A
W1048	Main DC OK Signal Contact B
W1049	Battery Voltage (+)
W1050	Battery Voltage (-)
W1051	Battery Voltage Circuit Breaker
W1052	BAT DISCHARGE Signal Contact A
W1053	BAT DISCHARGE Signal Contact B
W1054	BAT FAIL Signal Contact A
W1055	BAT FAIL Signal Contact B
W1056	DC OK Signal Contact A
W1057	DC OK Signal Contact B
W1058	Spare
W1059	Inlet Fan Voltage and Speed Data
W1060	Outlet Fan Voltage and Speed Data

3 Fuses

Follow the below steps for fuse replacing.

* F : Fuse
 F1-F2-F3-F4-F5-F6-F7-F8 = 1A
 F9-F10 = 2A
 F11 = 2.5A

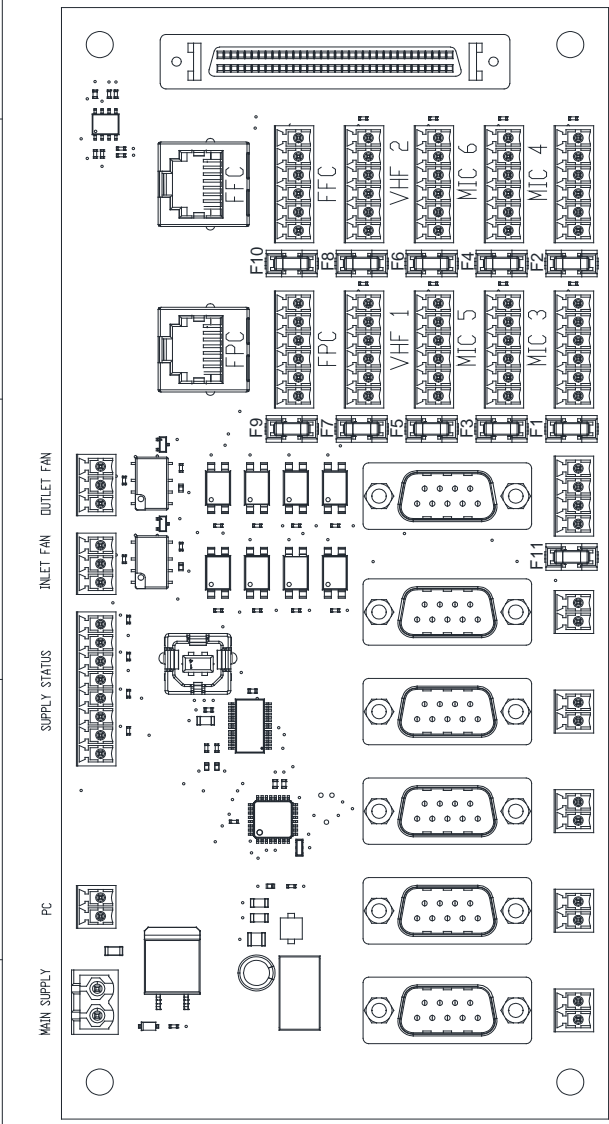

Warning : Power must be shot down before changing any fuse!
 Warning : Release your static electric before touching distribution panel.
 Attention : Do not harm the protection plate during any operation.
 Attention : Use proper tool for not to harm fuse while replacing.

* Remove the protection plate before replacing any fuses.

* F : Fuse
 * R : Remote Alarm Panel
 * Log : Speed Log

		OCEAN VOYAGER MARINE ELECTRONICS SYSTEMS	
DRAWING	NAME	DATE	
APPROVED	MUSTAFA DUYSAK	02.06.2021	
	RECEP	SEVGIKT	02.06.2021
REVISION NO	DIMENSIONS IN MM		SIMPLIFIED VOYAGE DATA RECORDER
			DR-100S
			DOCUMENT CODE: OCN.MD.101

Remarks